

# HIENASD



Fluid Dynamics

Structural Mechanics

Electromagnetics

Systems and Multiphysics

**Thorsten Hansen**  
**ANSYS Germany GmbH**

# Computational Domain

- $C_{ref\_mean} = 0.3445 \text{ m}$
- $100 * C_{ref}$  in all directions

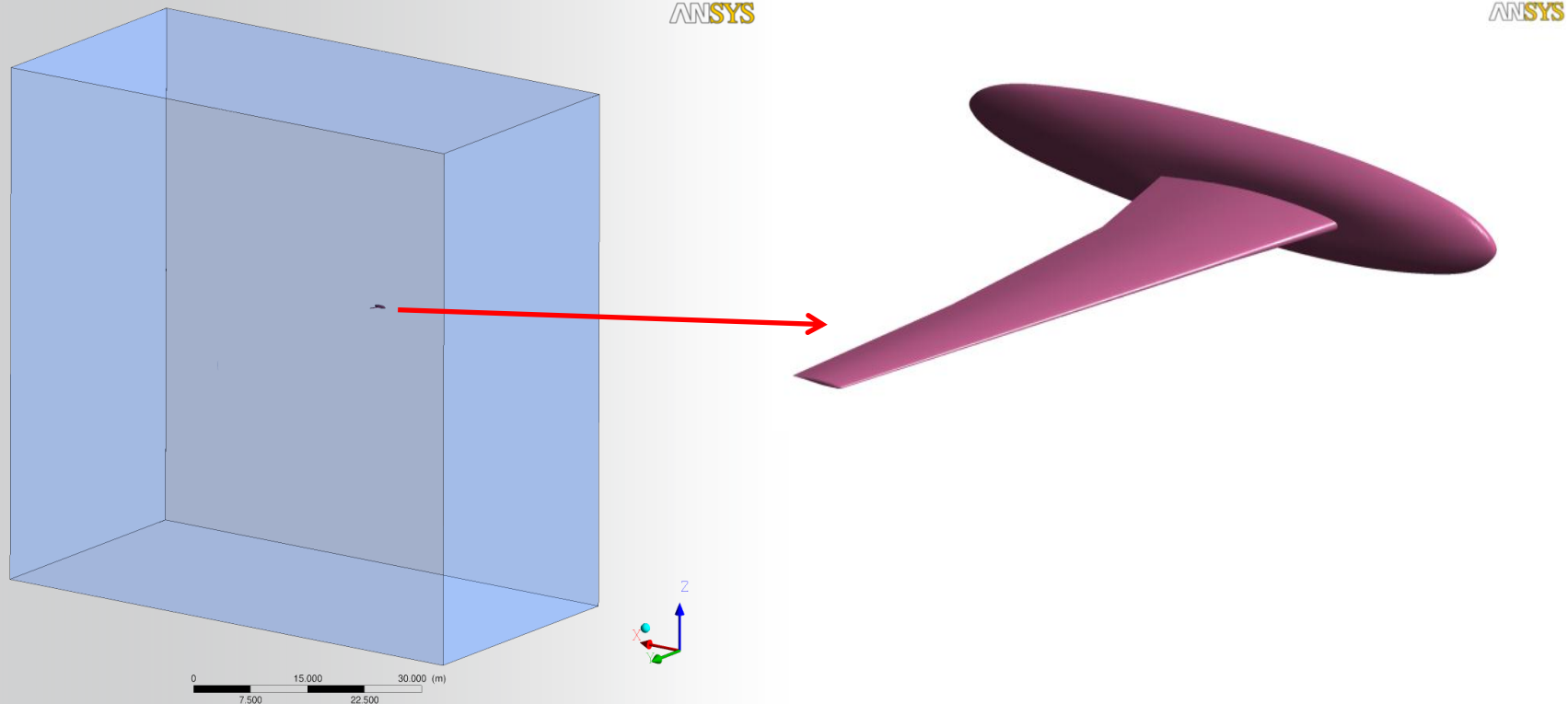

- ANSYS ICEM CFD 14
- Hexahedral elements
- Scalable grids
  - Consistent mesh quality upon grid refinement
- Multigrid
  - levels = 3

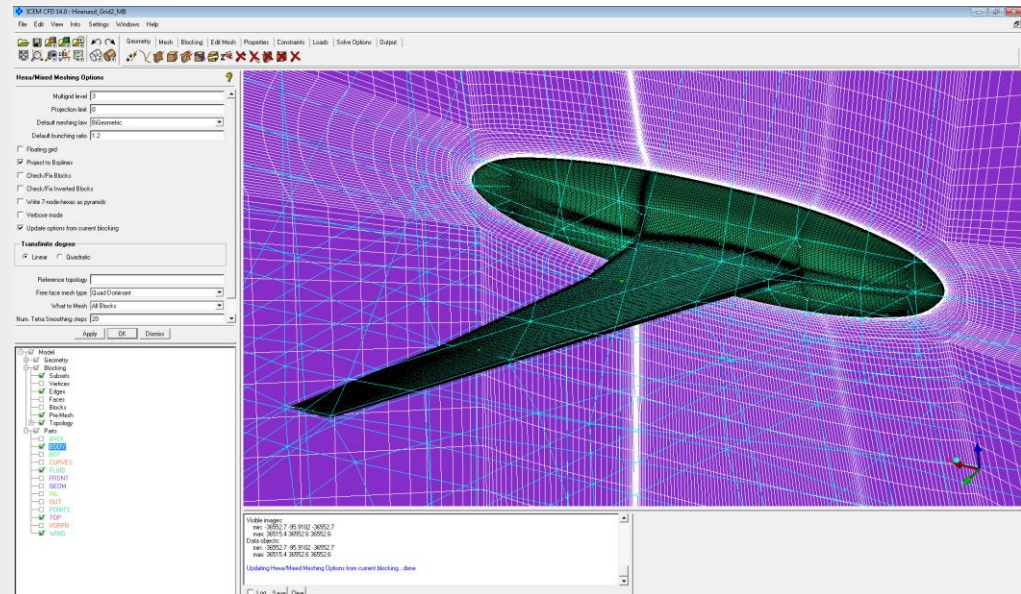

# Grid Information

	<b>Grid 1</b>	<b>Grid 2</b>	<b>Grid 3</b>
<b>Number of nodes</b>	<b>3,158,849</b>	<b>10,025,769</b>	<b>28,458,329</b>
<b>Number of elements</b>	<b>3,088,384</b>	<b>9,872,384</b>	<b>28,149,248</b>
<b>Minimum grid angle</b>	<b>23.3°</b>	<b>24.17°</b>	<b>24.33°</b>
<b>Maximum aspect ratio</b>	<b>149,529</b>	<b>125,250</b>	<b>134,515</b>
<b>First grid node @ Wall, m</b>	<b>4.4e-07 m (<math>y^+=0.58</math>)</b>	<b>2.94e-07 m (<math>y^+=0.41</math>)</b>	<b>1.96e-07 m (<math>y^+\sim 4/9</math>)</b>

# Grid Information

## Grid 1

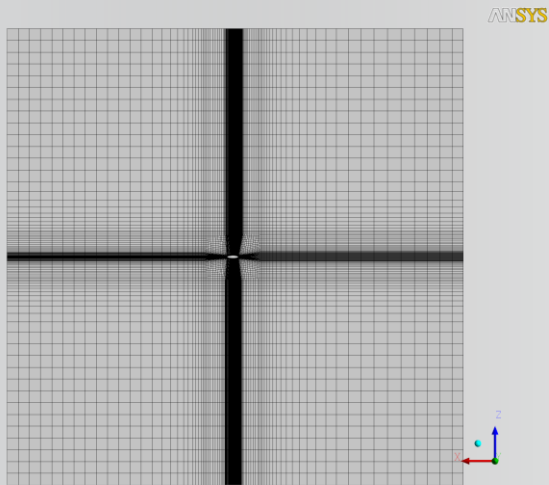

## Grid 2

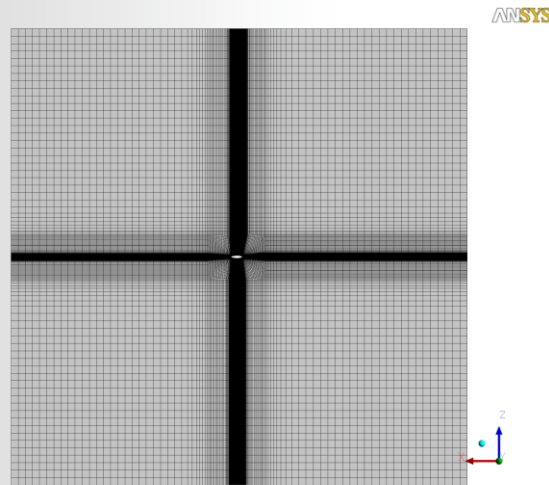

## Grid 3

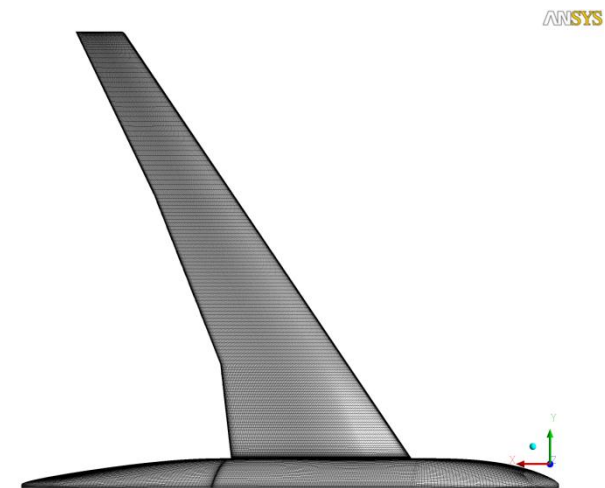
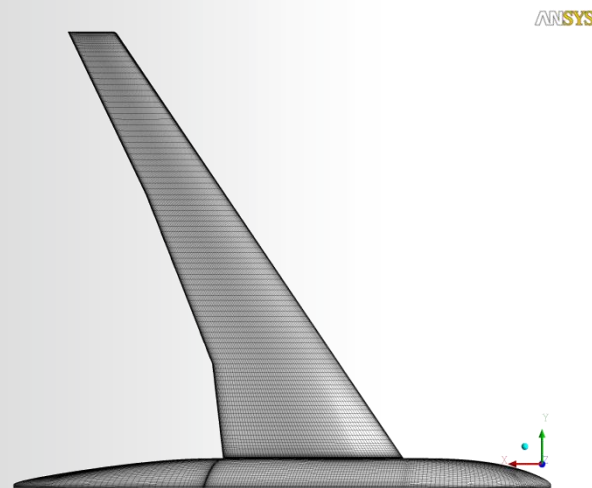
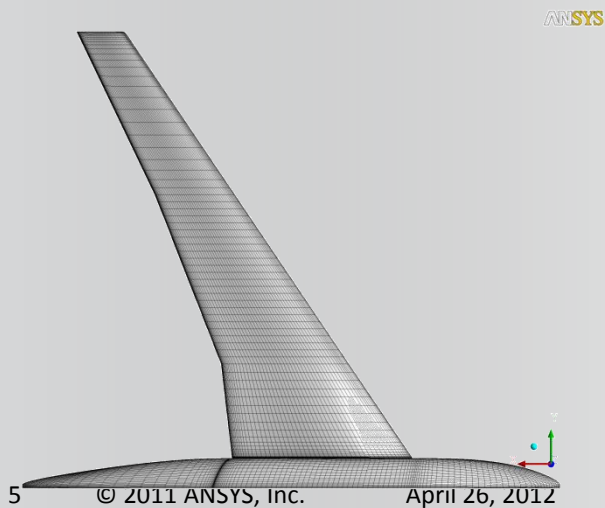
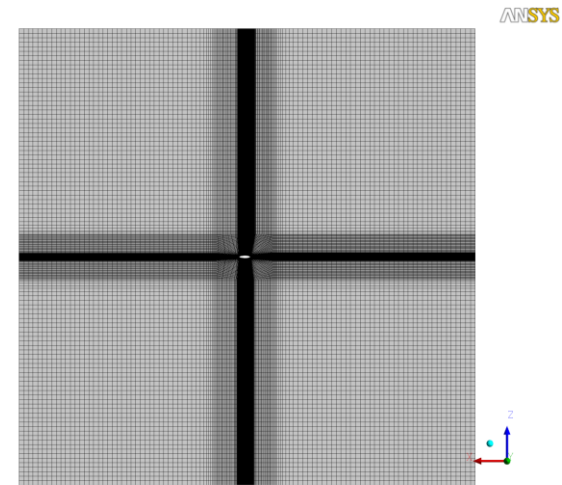



# Grid Information

## Grid 1

## Grid 2

## Grid 3

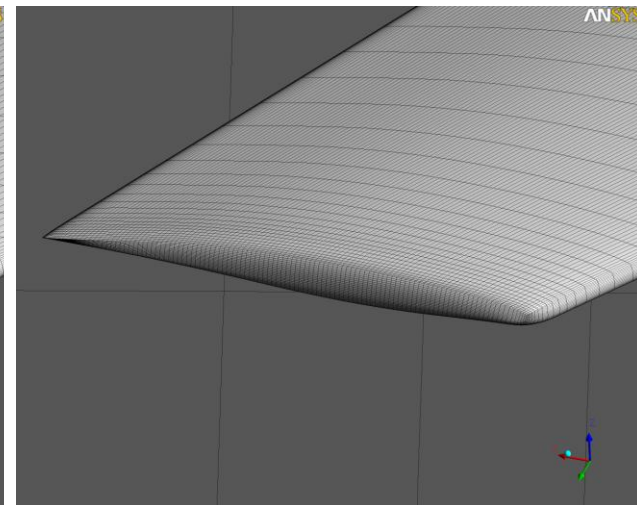
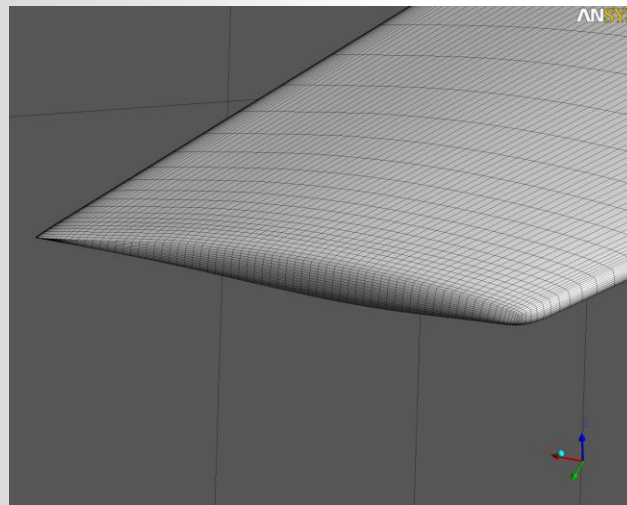
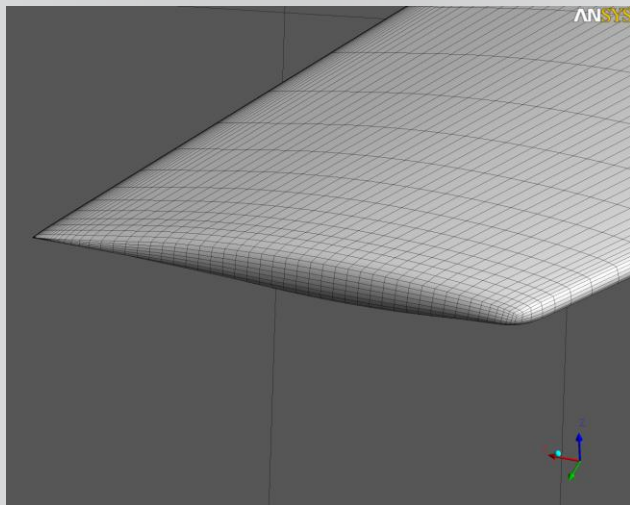
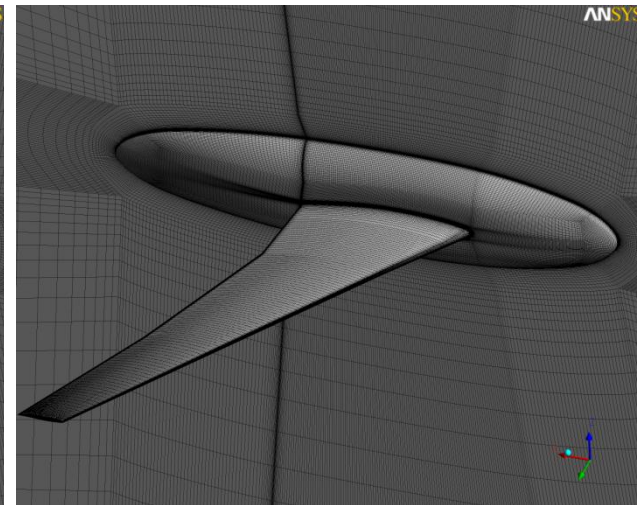
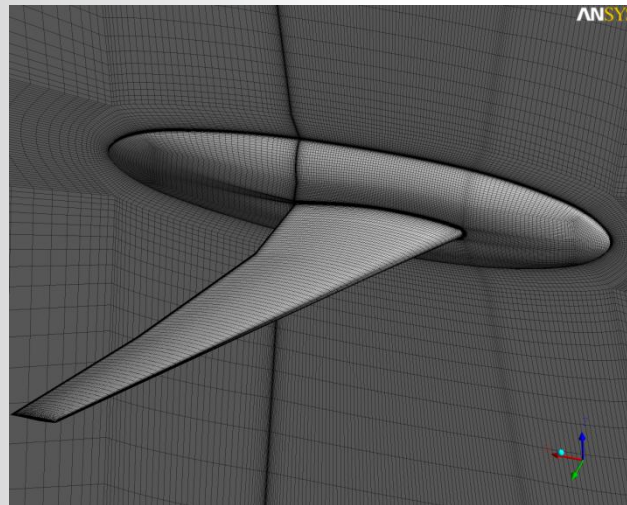
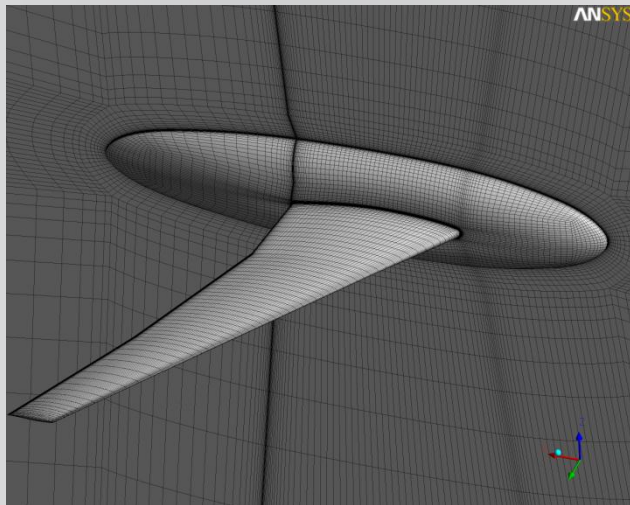

# Grid Information

## Grid 1

## Grid 2

## Grid 3

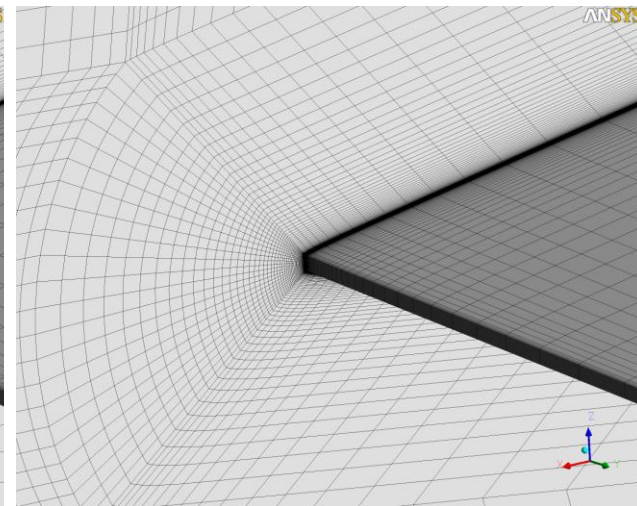
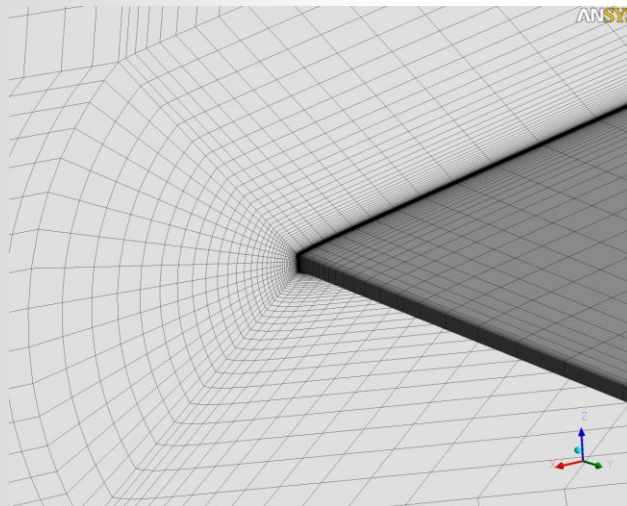
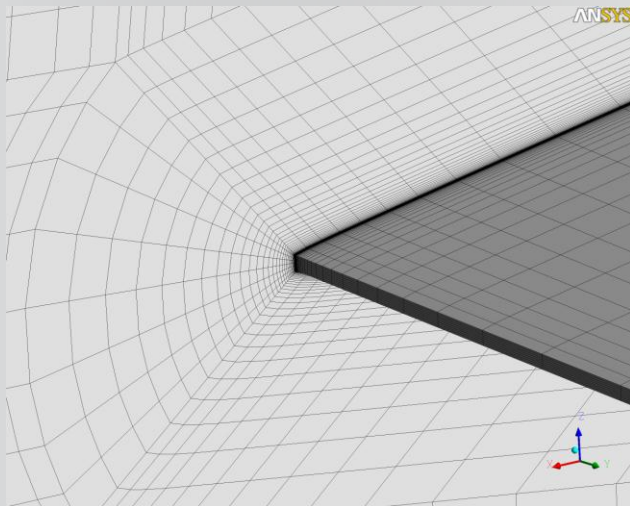
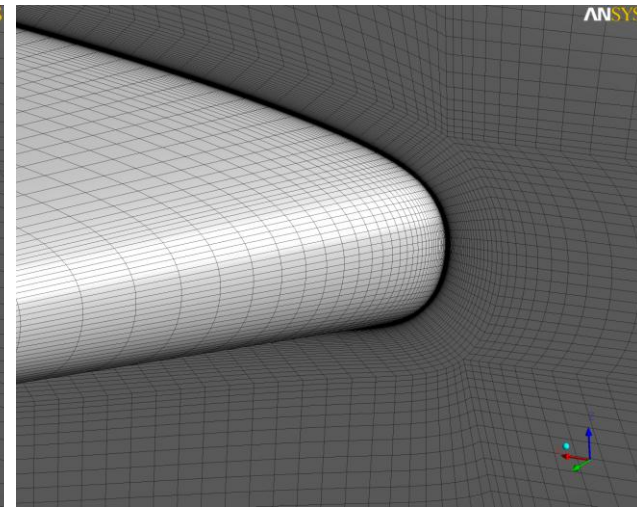
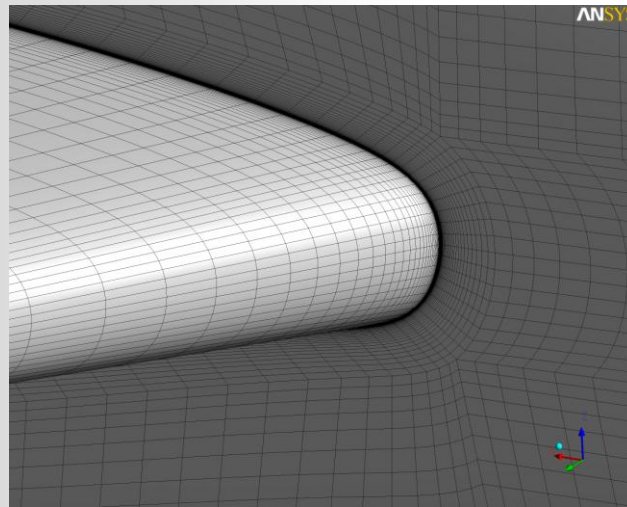
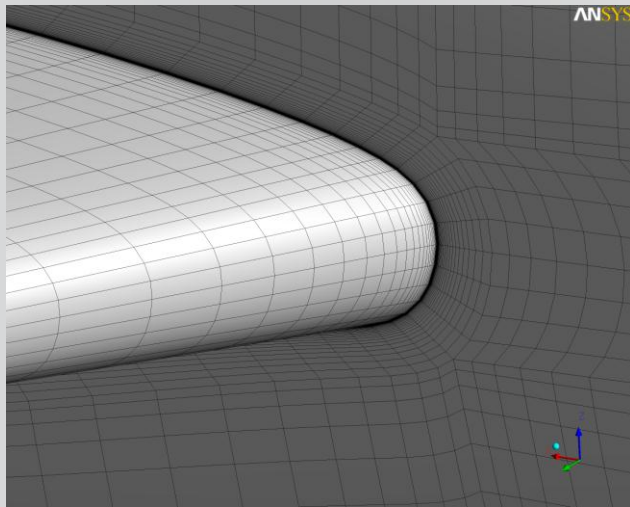

## FEM Grid

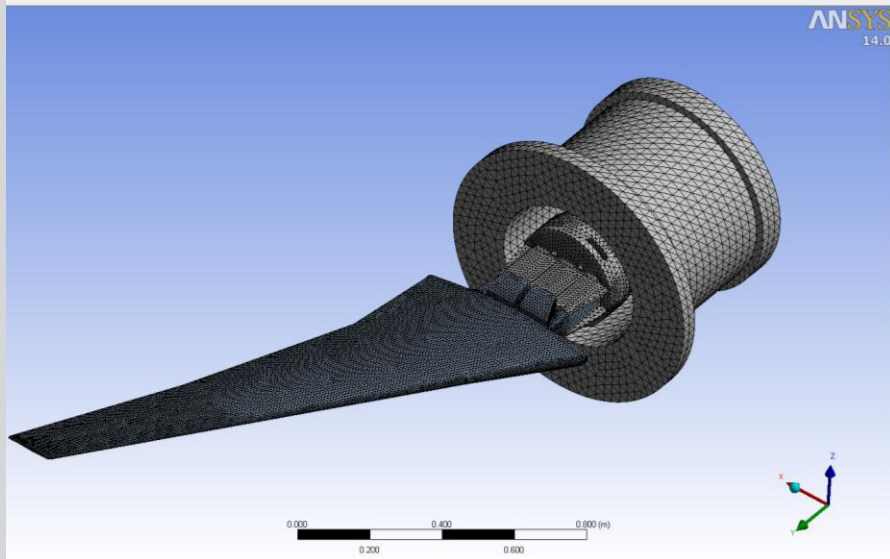

Downloaded from the AePW website

## CFD Grid

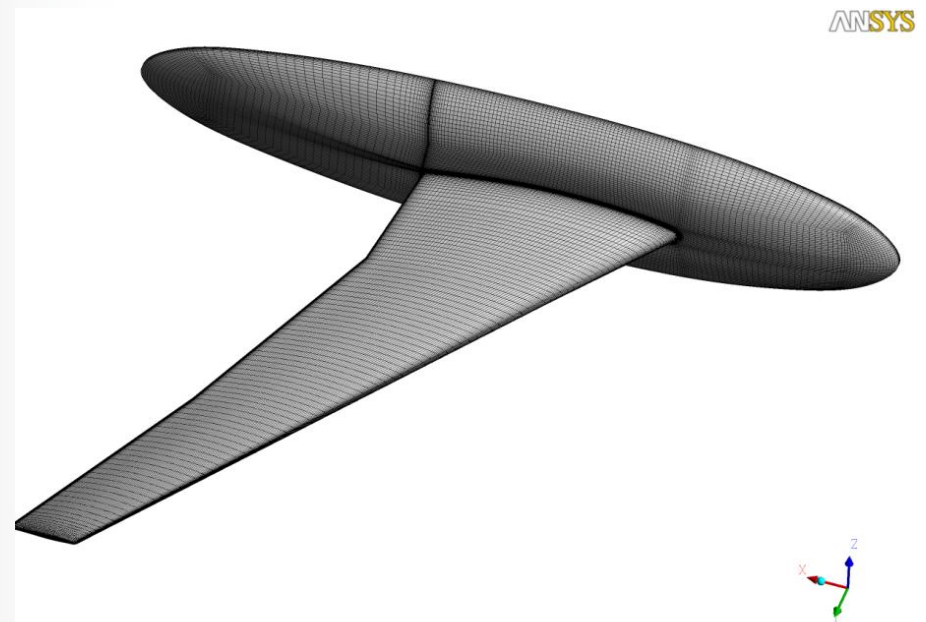



# Grid Plane @ Eta = 0.145

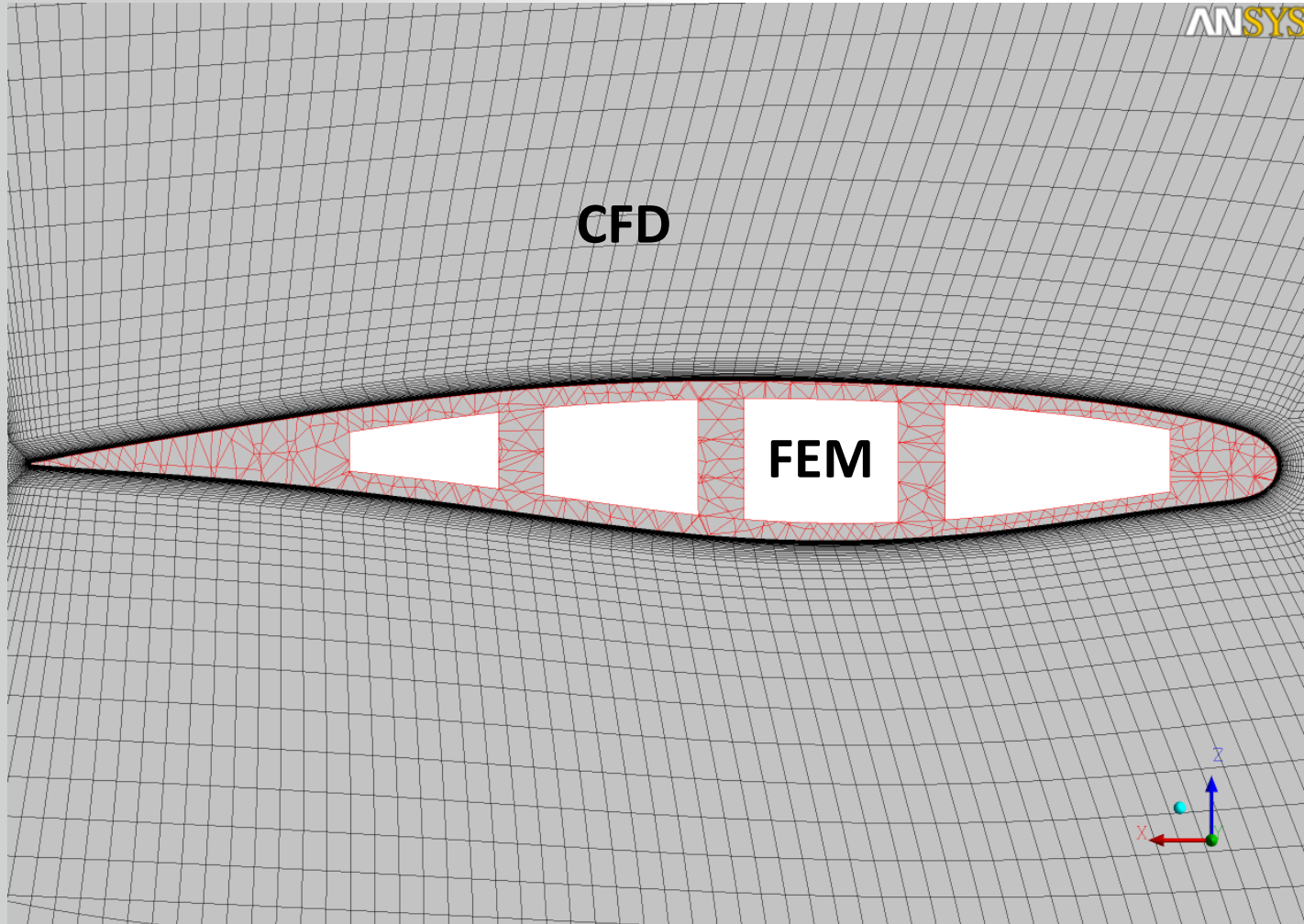

# Grid Plane @ Eta = 0.145

## Leading Edge

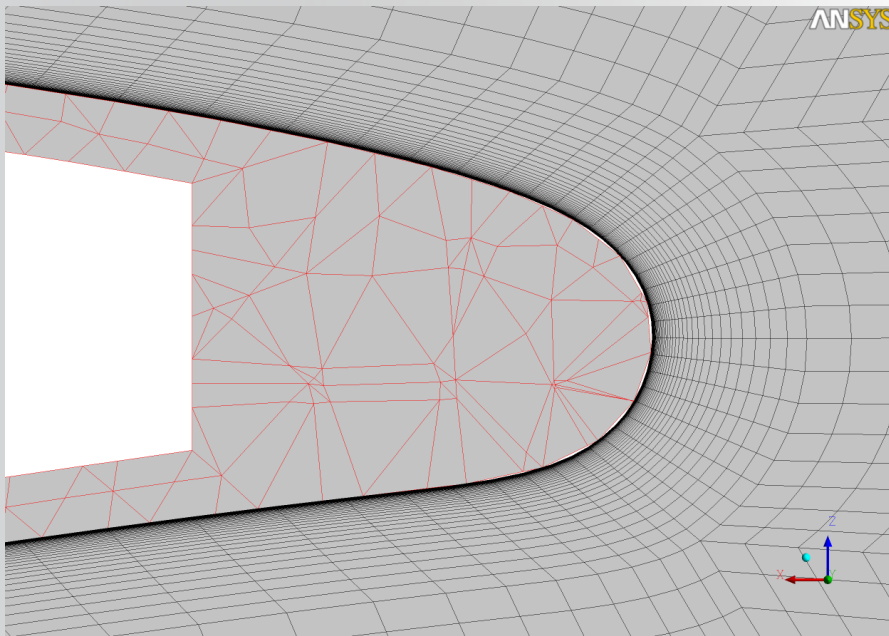

## Trailing Edge

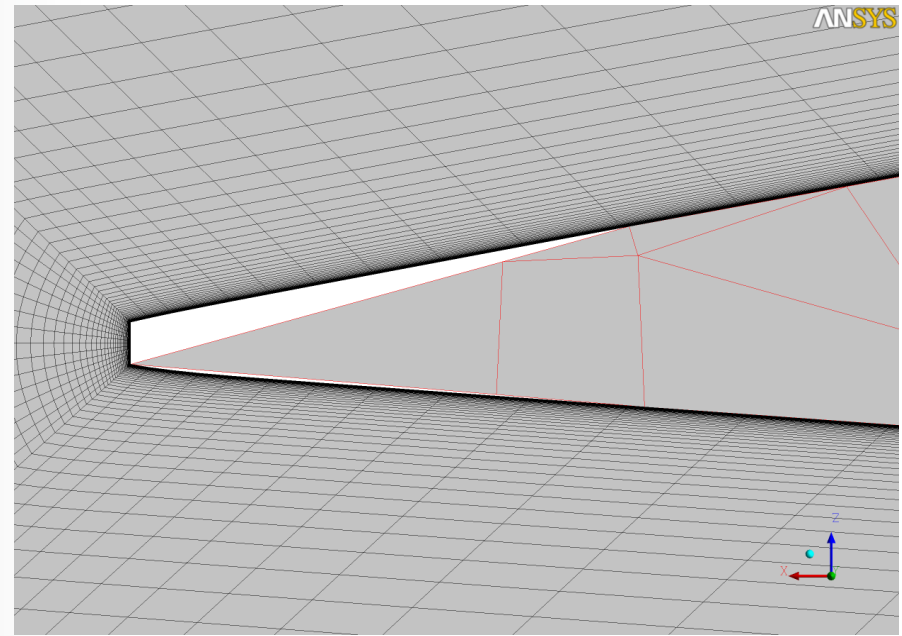

- ANSYS CFX 14
- Coupled (U,V,W,P) solver
  - Pressure based
- Convective discretization
  - High-resolution scheme
- Algebraic multigrid
- Vertex centred

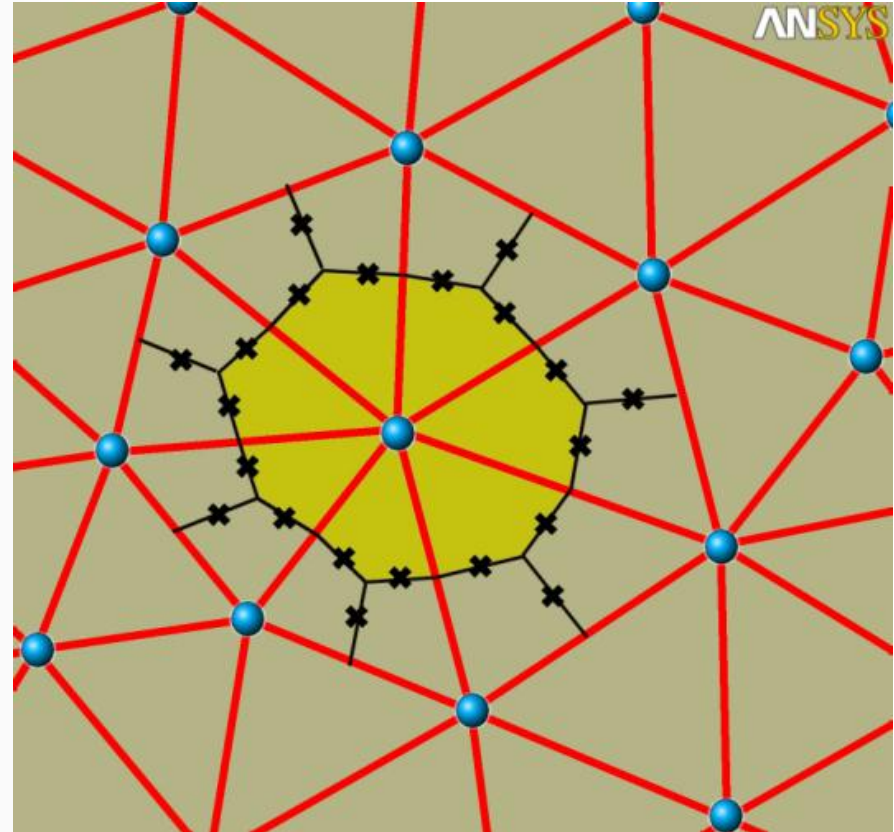

- Ensemble-averaged mass, momentum and energy conservation equations
- Turbulence model
  - SST (Menter, 1994)
- Automatic choice of linear/logarithmic near wall profiles

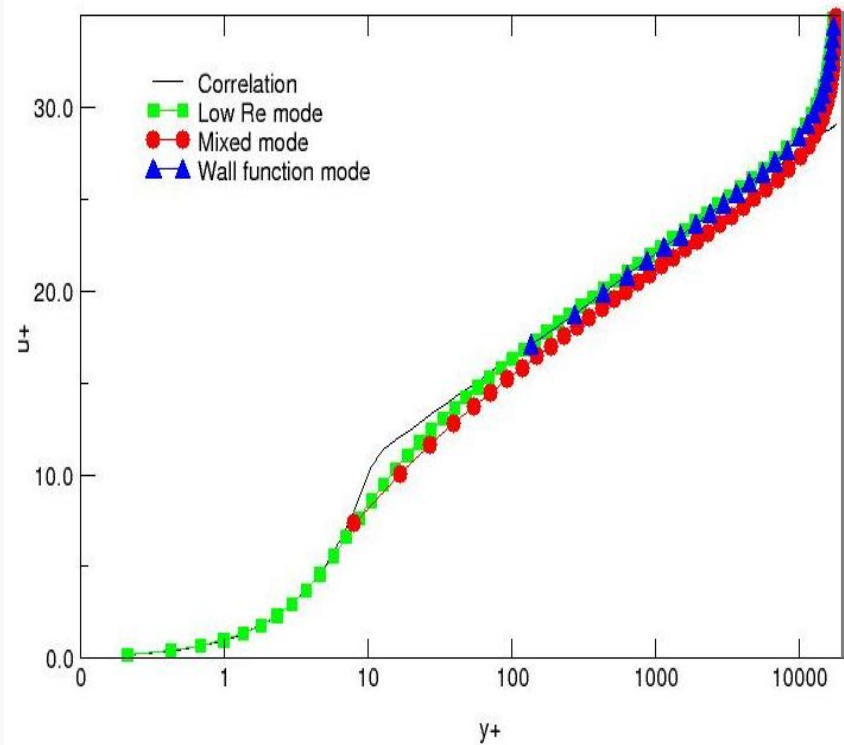

Automatic Wall Treatment



# Solver Information

	<b># of CPUs</b>	<b>Total Wall Clock Time, h</b>	<b>Memory, GByte</b>
<b>Grid 1</b>	<b>12</b>	<b>3 h 19 min</b>	<b>8.05</b>
<b>Grid 2</b>	<b>36</b>	<b>3 h 11 min</b>	<b>25.58</b>
<b>Grid 3</b>	<b>96</b>	<b>4 h 2 min</b>	<b>72.06</b>

# CFX Solver Information, ETW 132

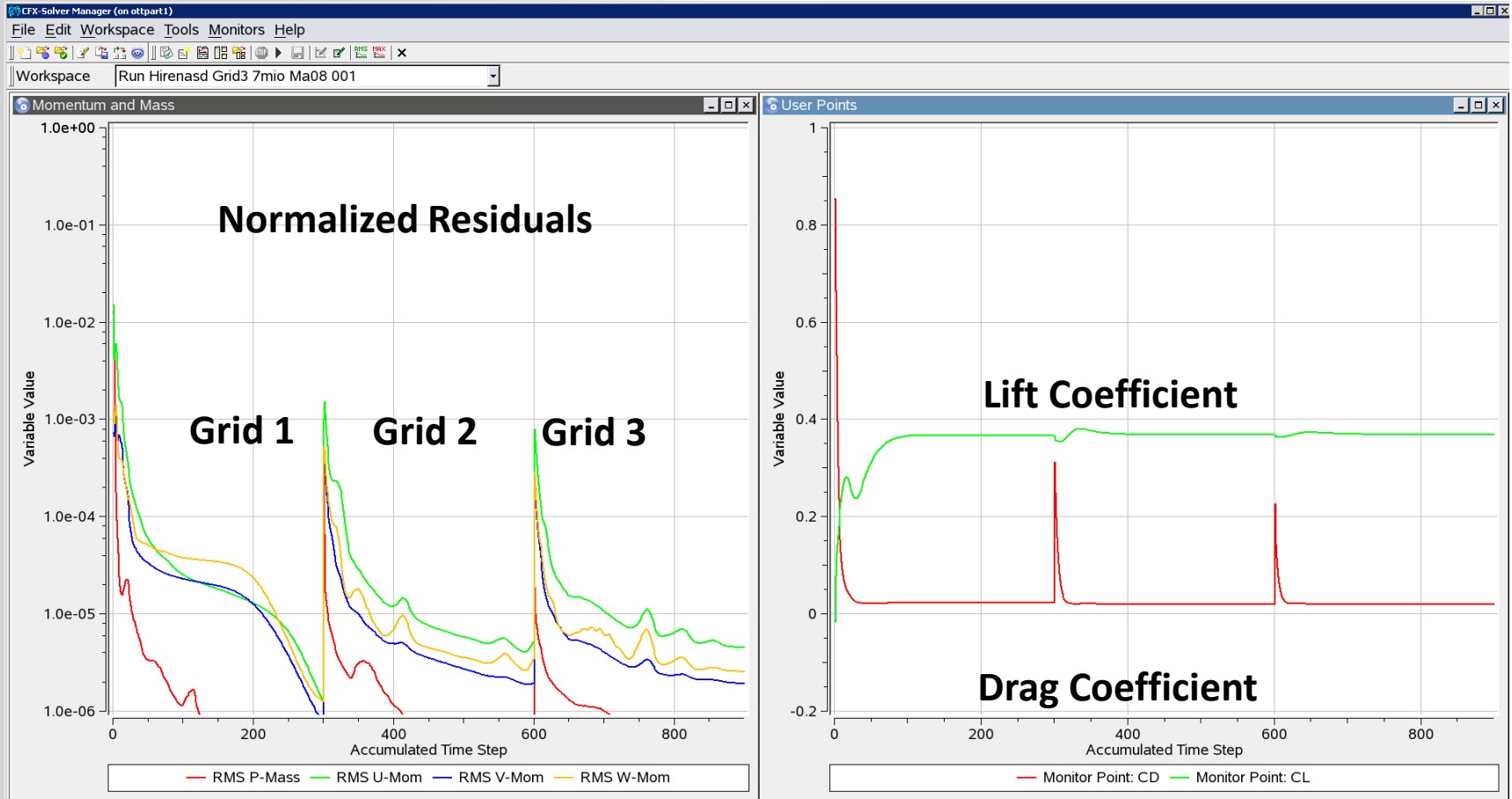

# CFX Solver Information, ETW 250

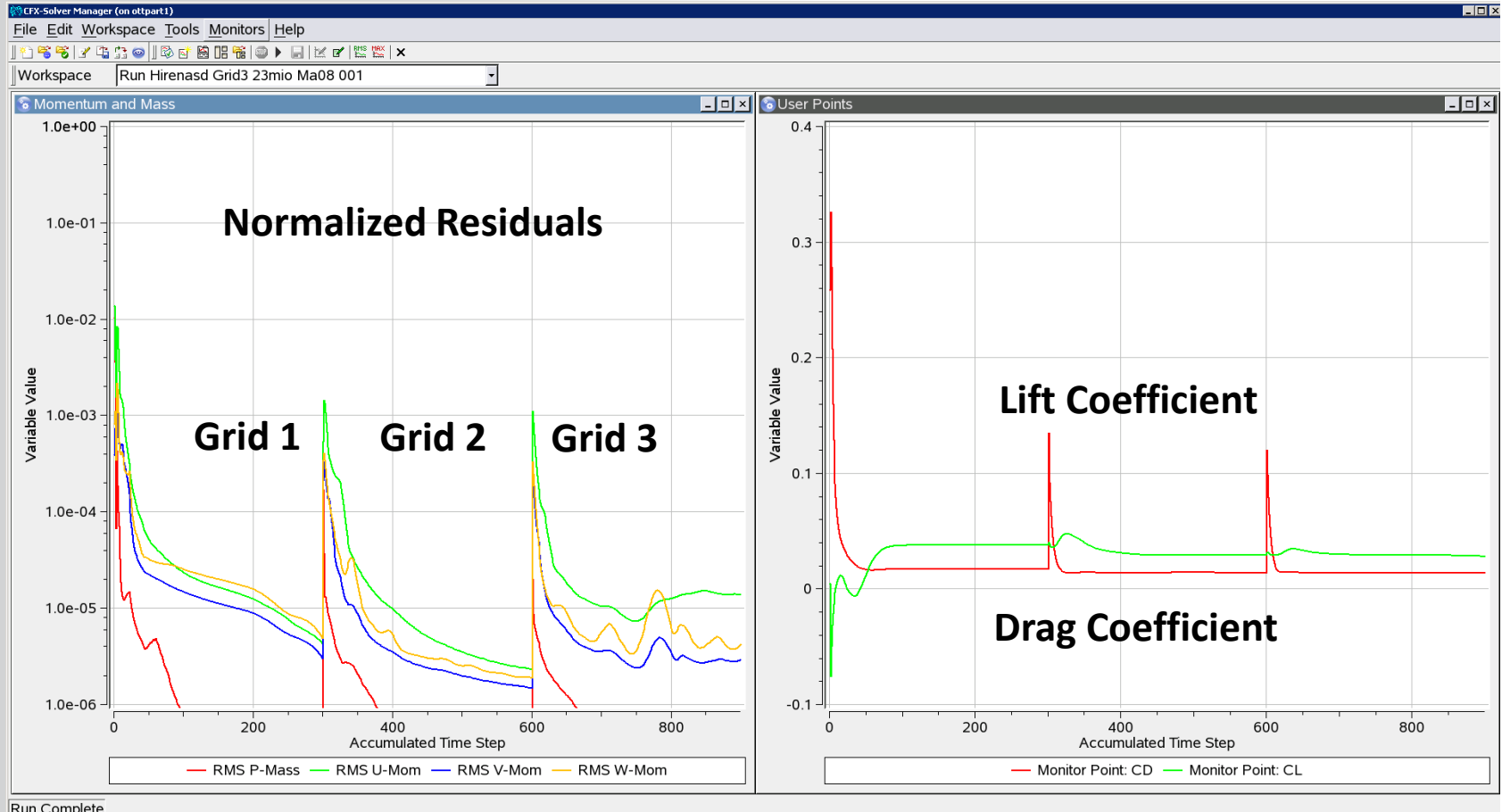

# CP & Ma, Re = 7 mio, Ma = 0.8, $\alpha = 1.5^\circ$

Grid 1

Grid 2

Grid 3

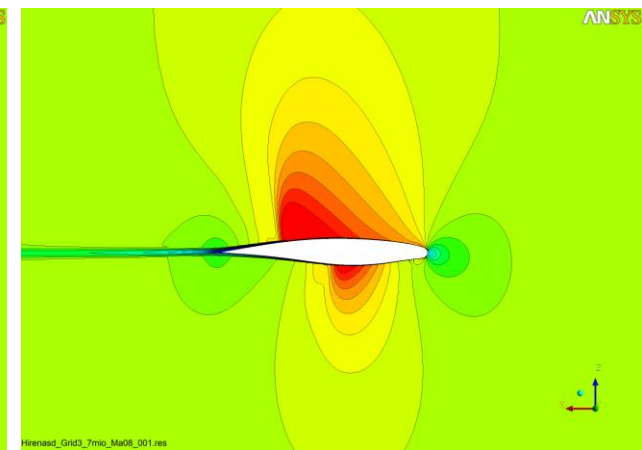
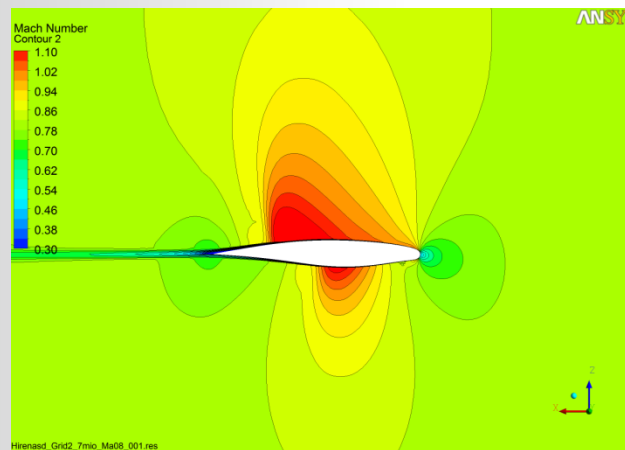
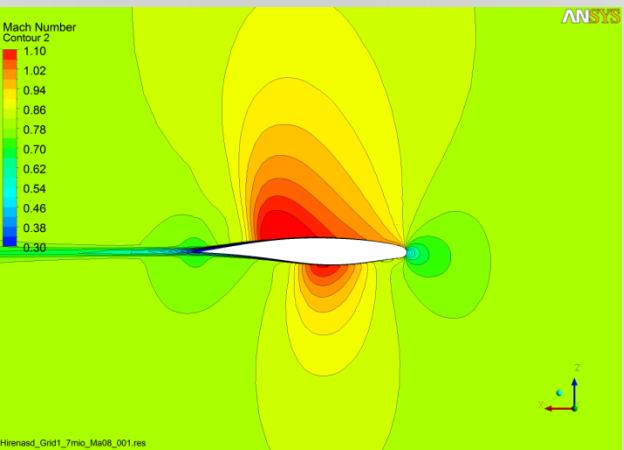
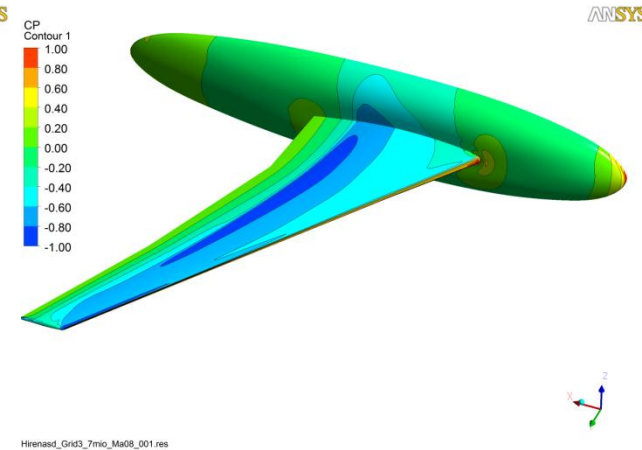
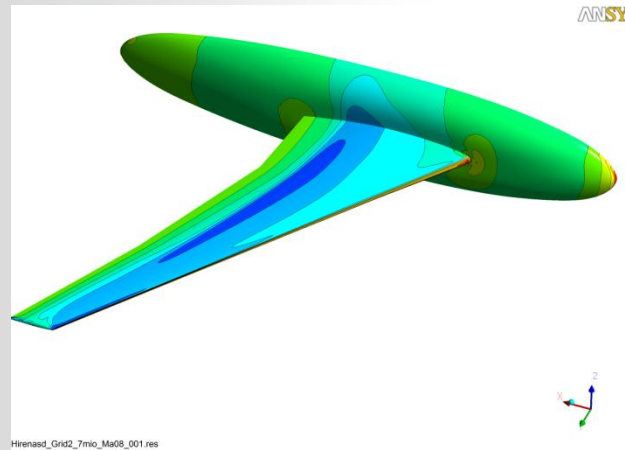
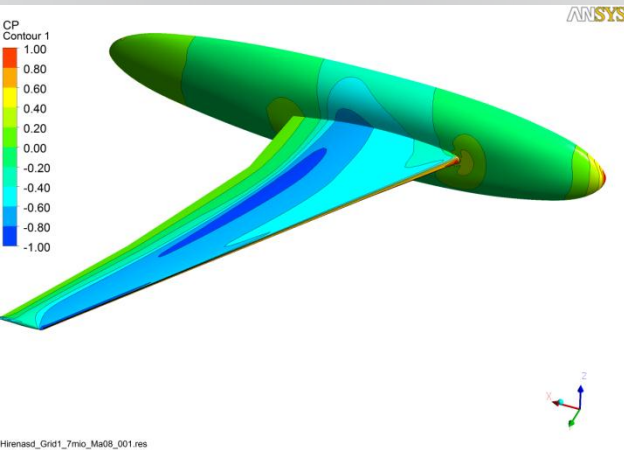



# CP, $Re = 23.5 \text{ mio}$ , $Ma = 0.8$ $\alpha = -1.34^\circ$

Grid 1

Grid 2

Grid 3

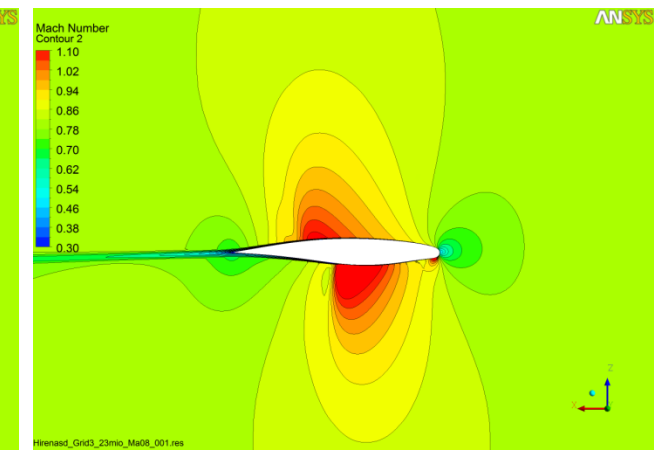
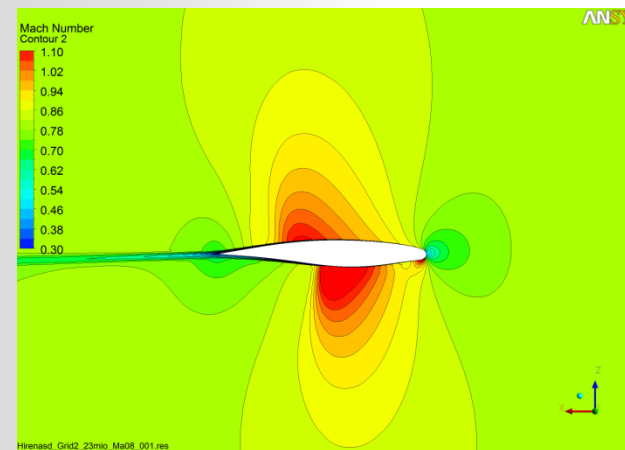
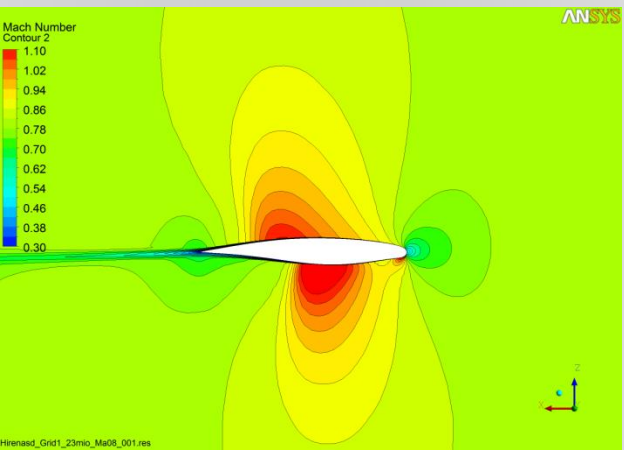
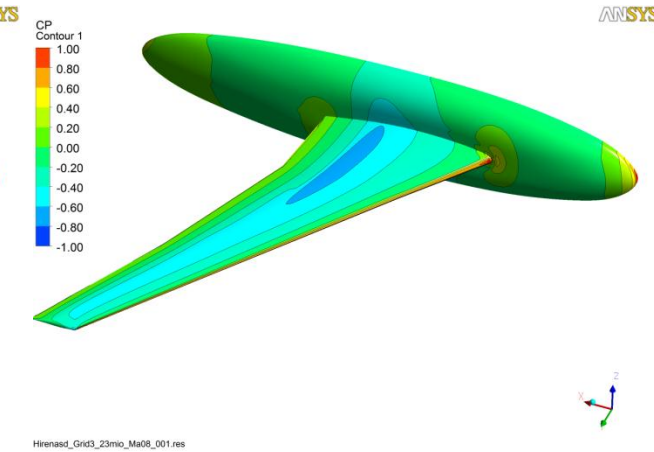
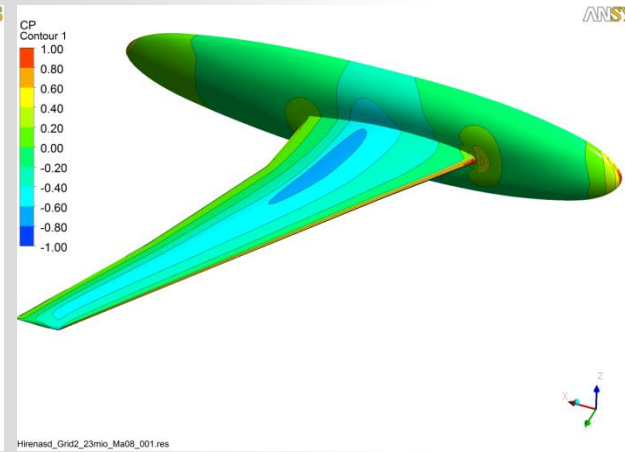
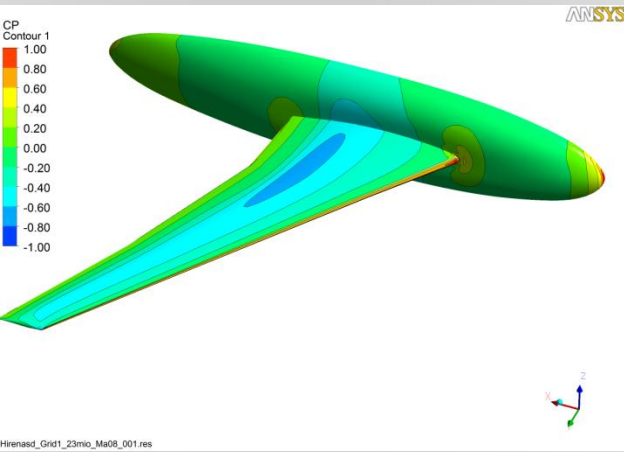

# ANSYS Solver Coupling

**Solve CFD undeformed grid**

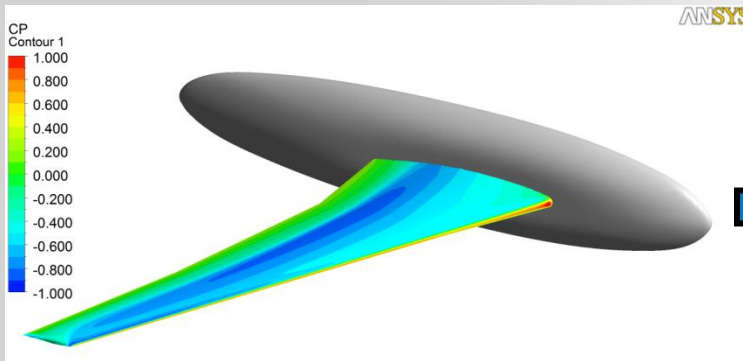

**Transfer CFD loads to FEA and solve structural deformation**

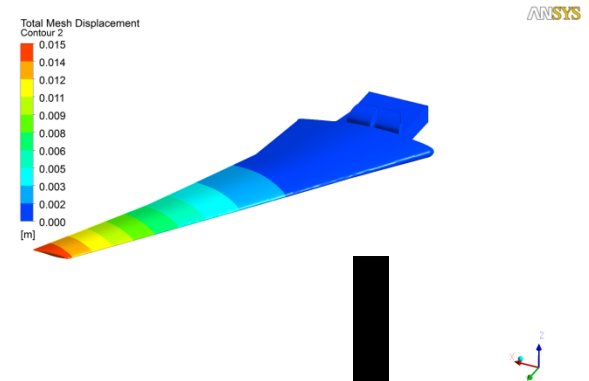

**Solve CFD deformed grid**

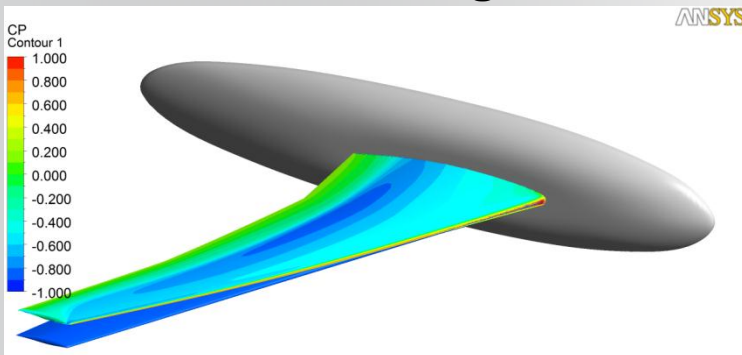

**Transfer deformation to FEA and solve mesh deformation**

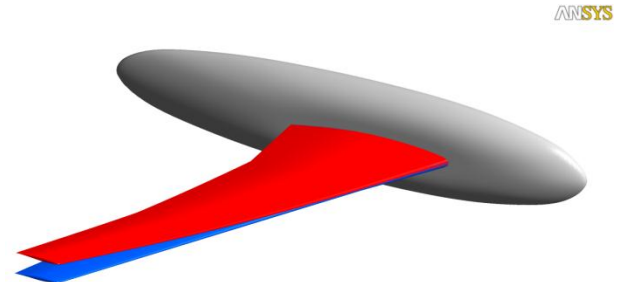

# Load Transfer Algorithms

- Different grids on CFD & FEM side
  - Topology
  - Grid width
- Load transfer
  - Search
  - Interpolation
- Interpolation algorithms
  - Profile preserving or
  - Globally conservative
  - Profile preserving & conservative → GGI technology

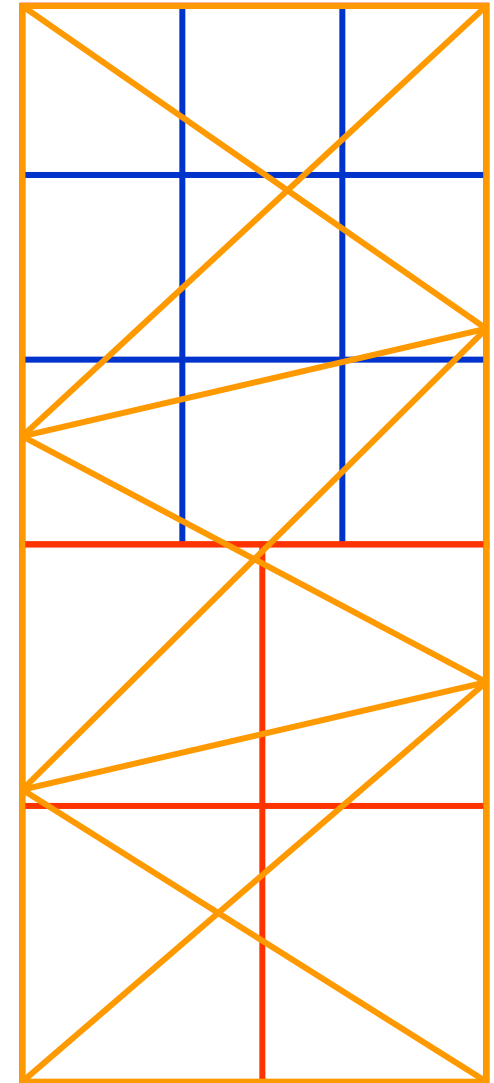
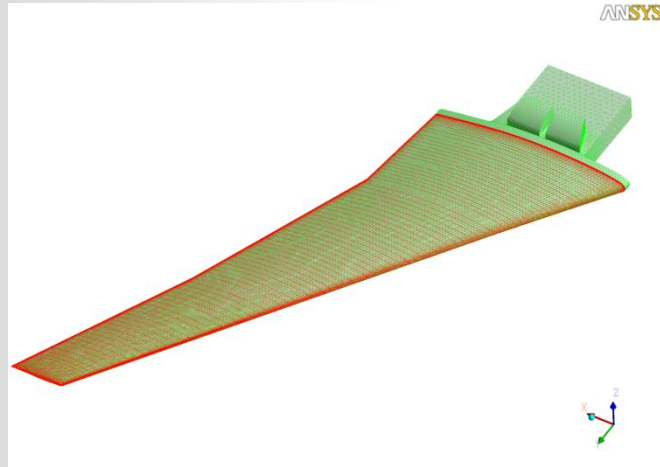

# Generalised Grid Interface

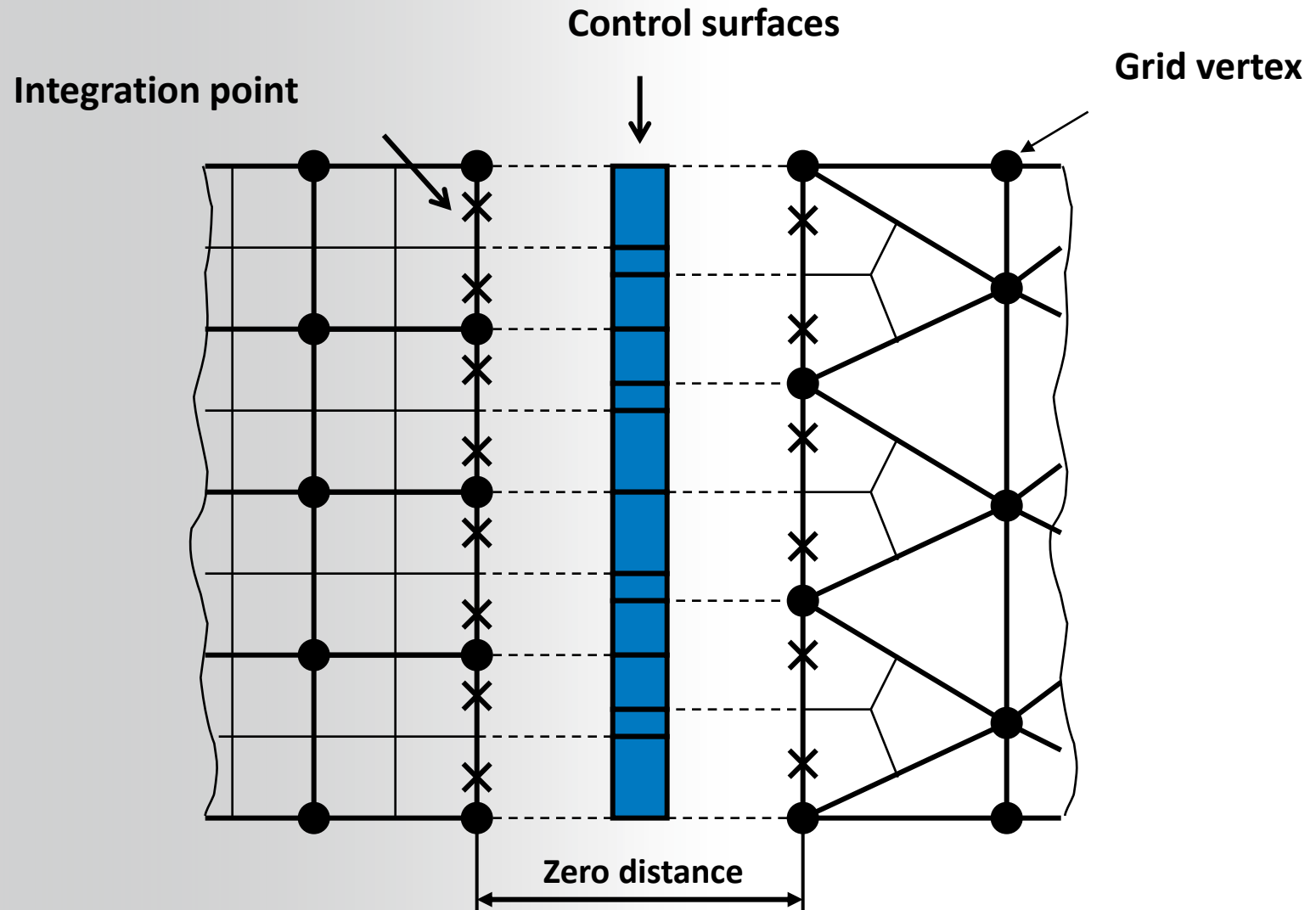



# Generalised Grid Interface

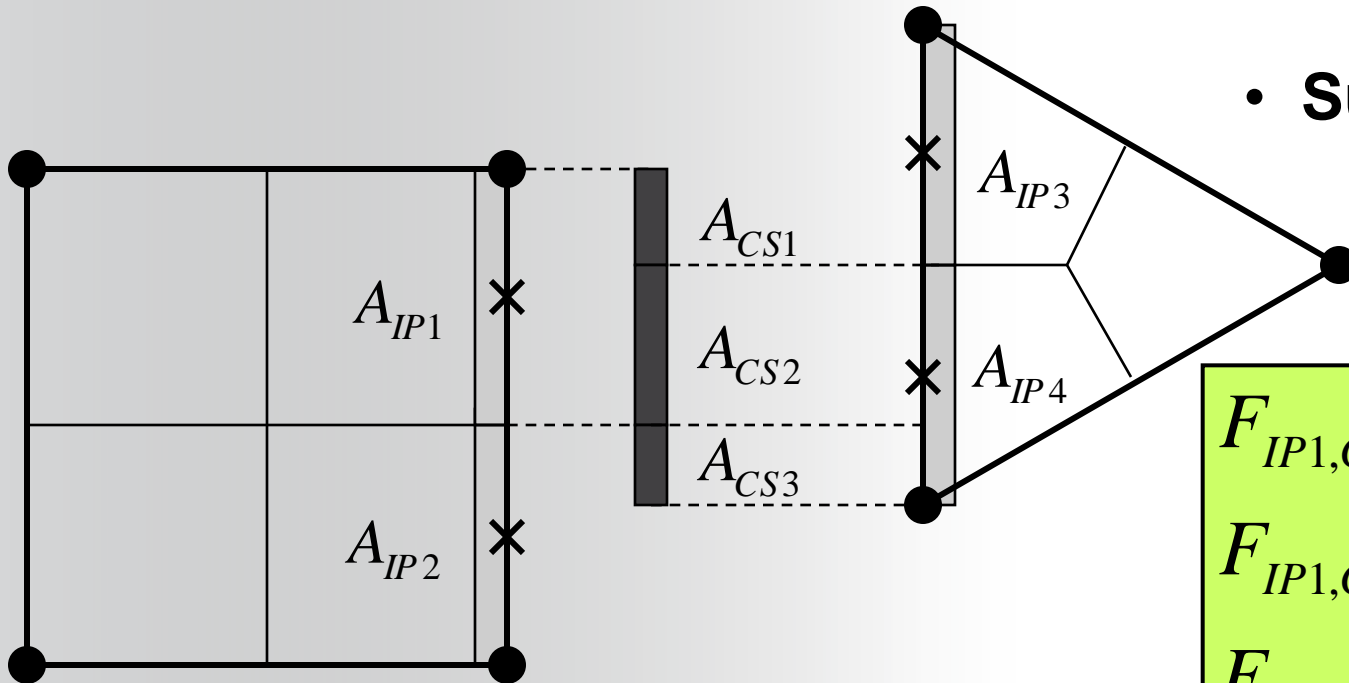

- Surface fractions

$$A_{IP1} \cap A_{IP3} = A_{CS1}$$

$$A_{IP1} \cap A_{IP4} = A_{CS2}$$

$$A_{IP2} \cap A_{IP4} = A_{CS3}$$

$$F_{IP1,CS1} = A_{CS1} / A_{IP1}$$

$$F_{IP1,CS2} = A_{CS2} / A_{IP1}$$

$$F_{IP2,CS3} = A_{CS3} / A_{IP2}$$

$$F_{IP3,CS1} = A_{CS1} / A_{IP3}$$

$$F_{IP4,CS2} = A_{CS2} / A_{IP4}$$

$$F_{IP4,CS3} = A_{CS3} / A_{IP4}$$

# Total Deformation @ CFX

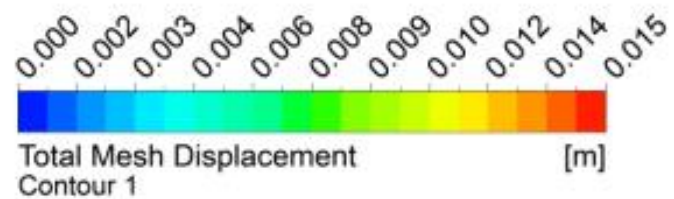
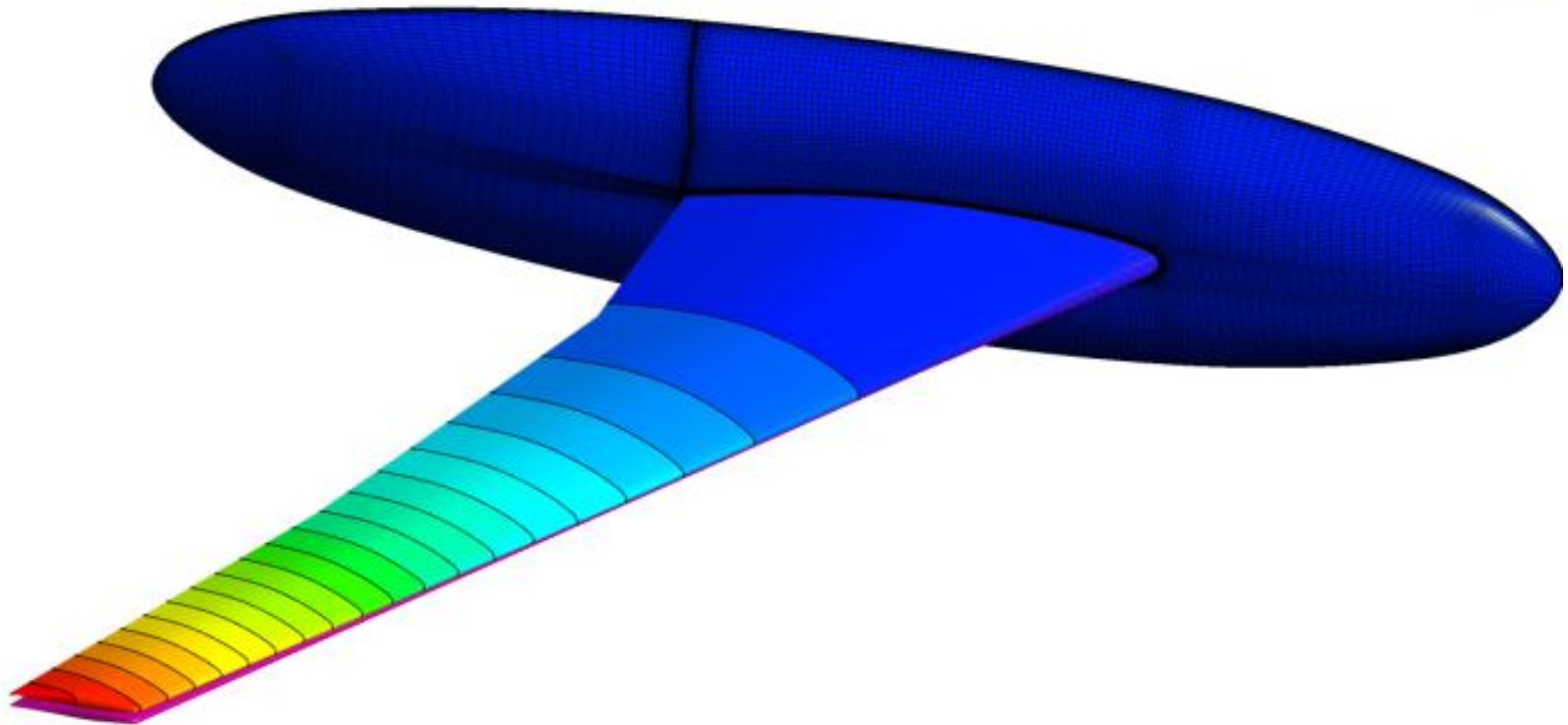

# Grid 2: Static Aeroelastic Equilibrium

$Re = 7 \text{ mio}$ ,  $Ma = 0.8$ ,  $\alpha = 1.5^\circ$

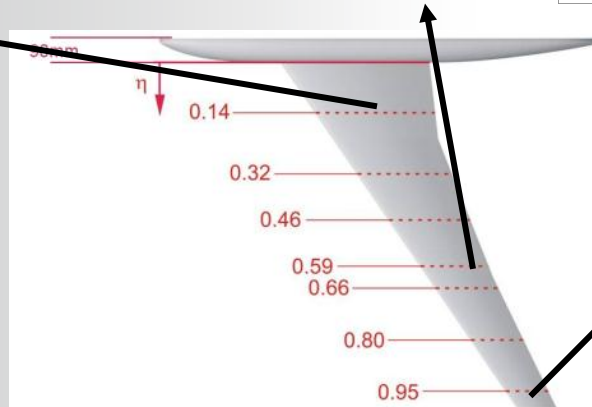
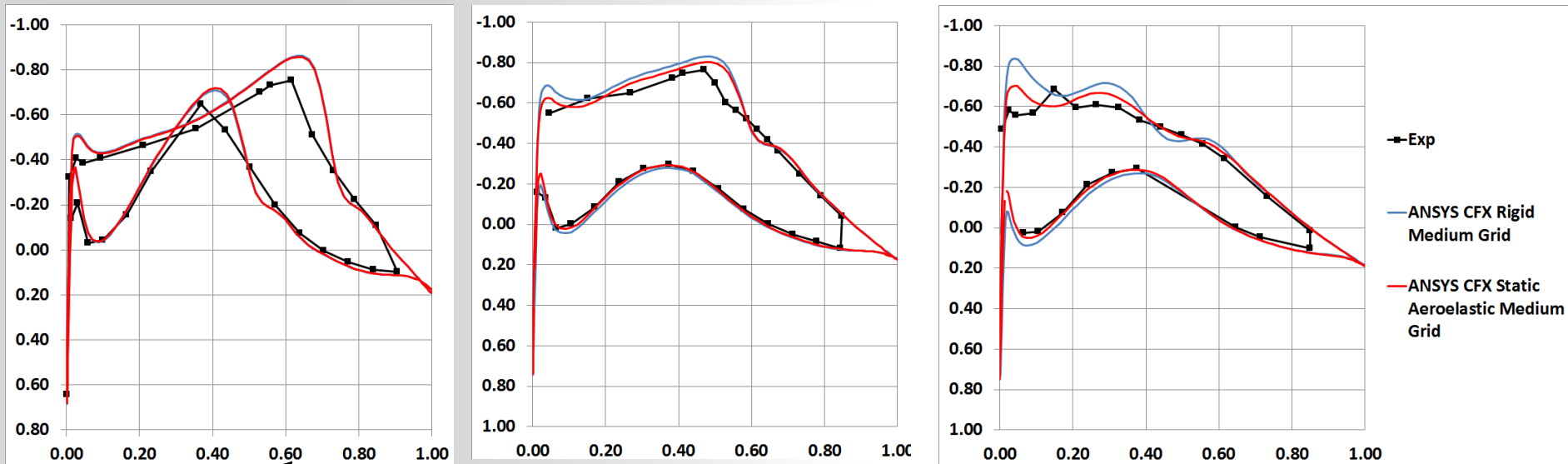

# Discretization Error

$Re = 7 \text{ mio}$ ,  $Ma = 0.8$ ,  $\alpha = 1.5^\circ$

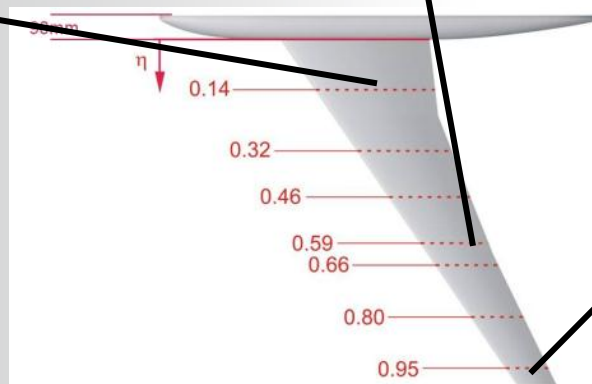
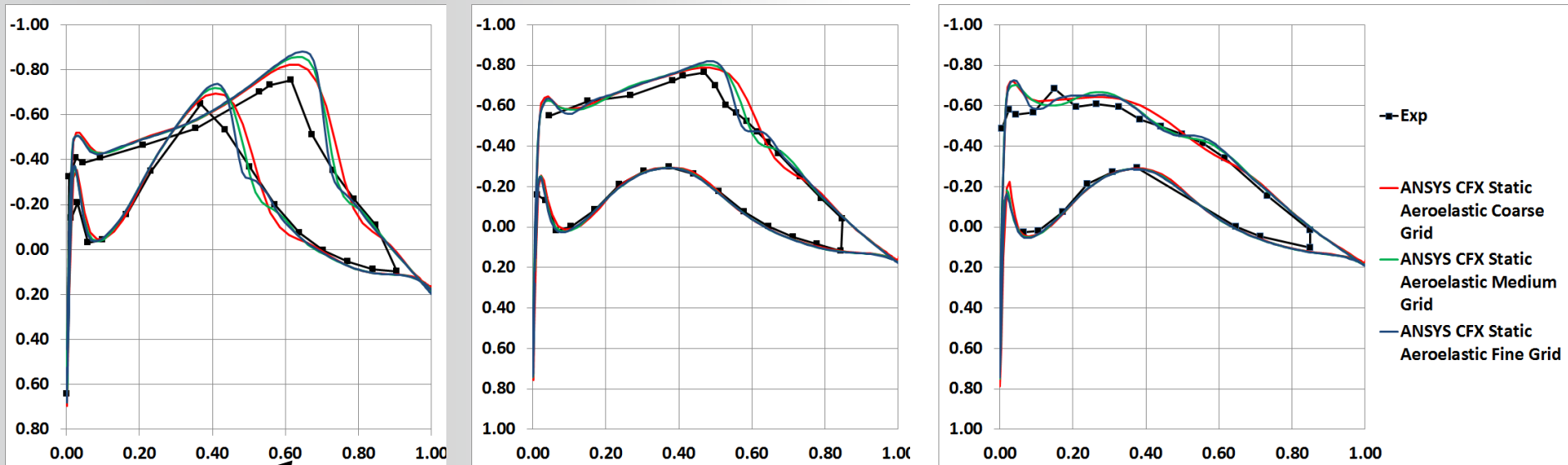



# Re = 7 mio, Ma = 0.8, a = 1.5°

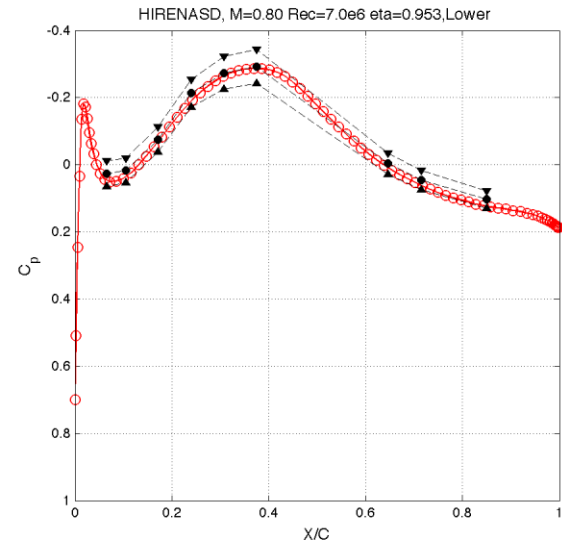
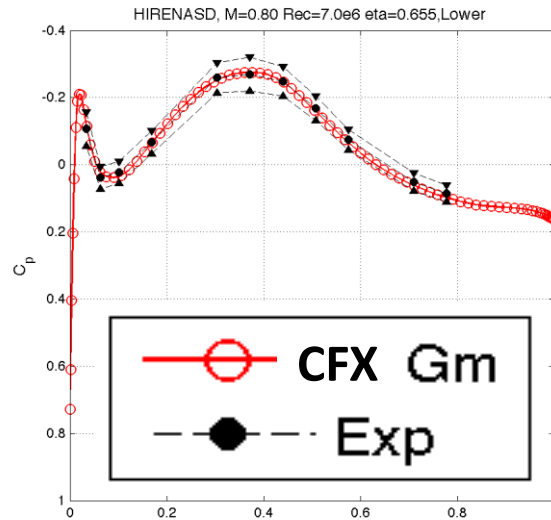
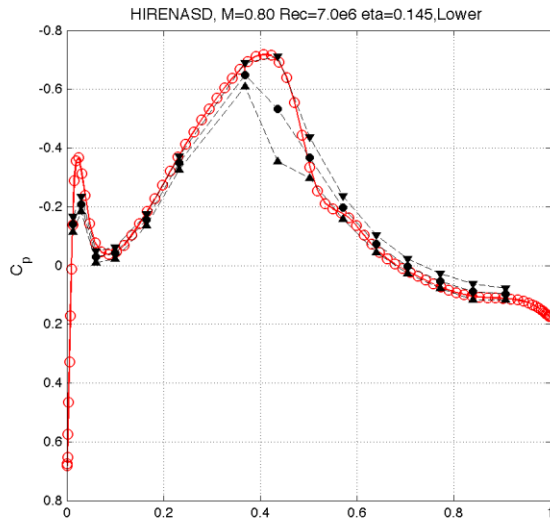

Plots created by Carol Wieseman, NASA

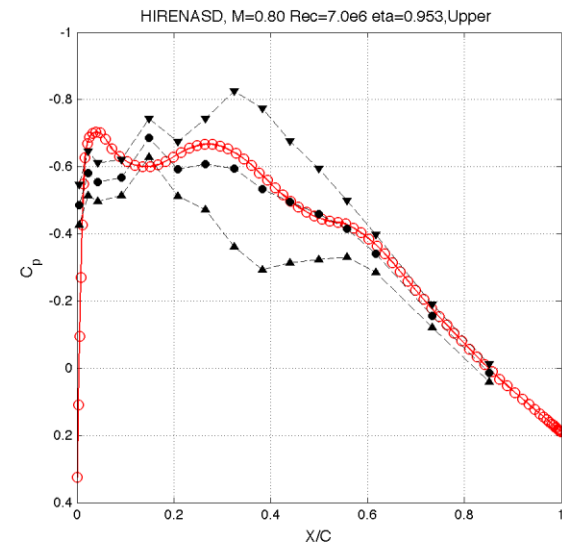
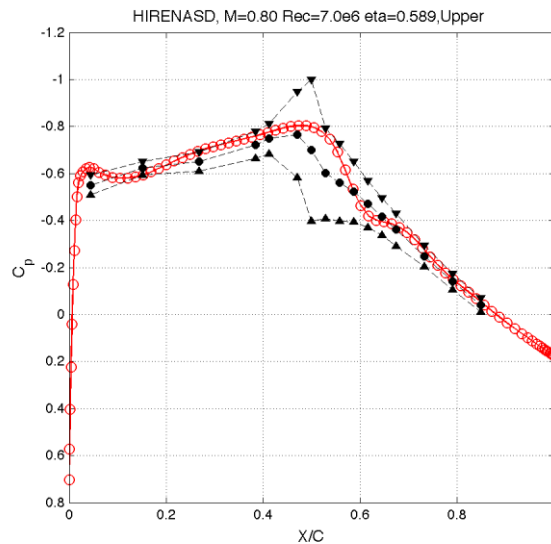
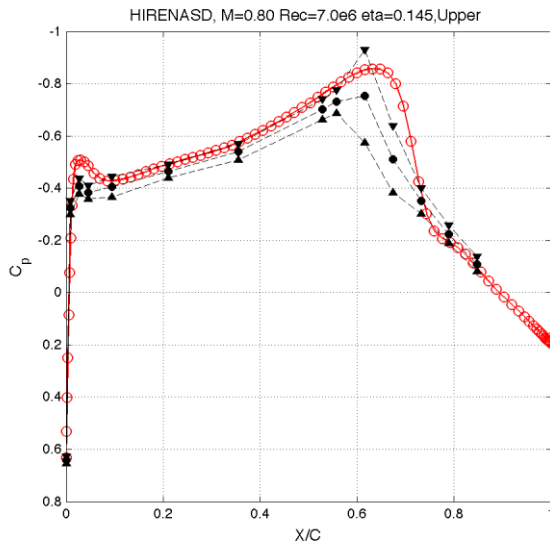

# ANSYS Modal Analysis, 2<sup>nd</sup> Bending

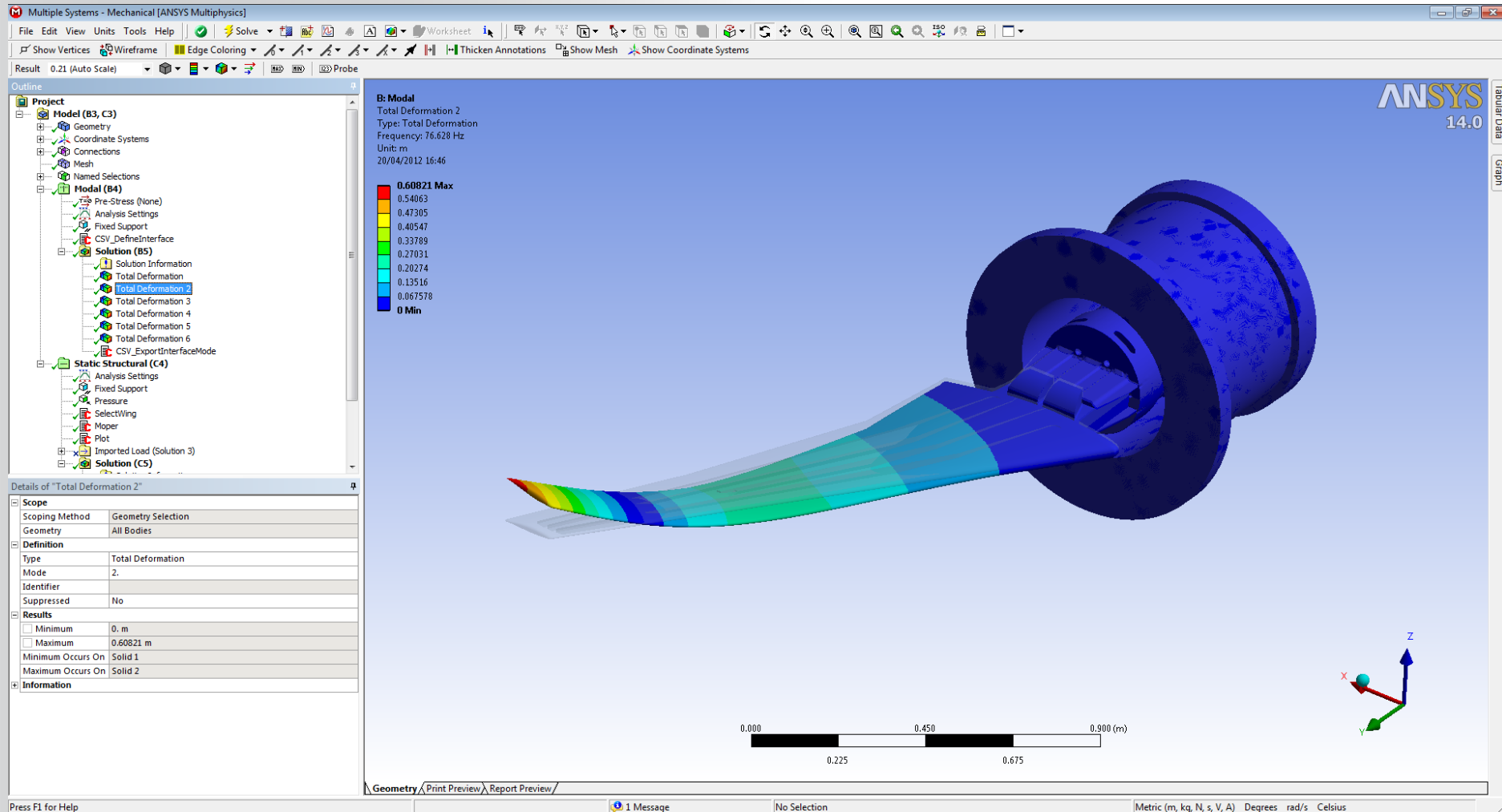

# Unsteady-State Calculation

- Oscillations for the 2<sup>nd</sup> bending mode
- Mesh displacement
  - Harmonic wing motion
  - $A \cdot \sin(\omega \cdot t)$
- Initial condition
  - Converged steady-state solution
- Monitor frequencies
- FFT

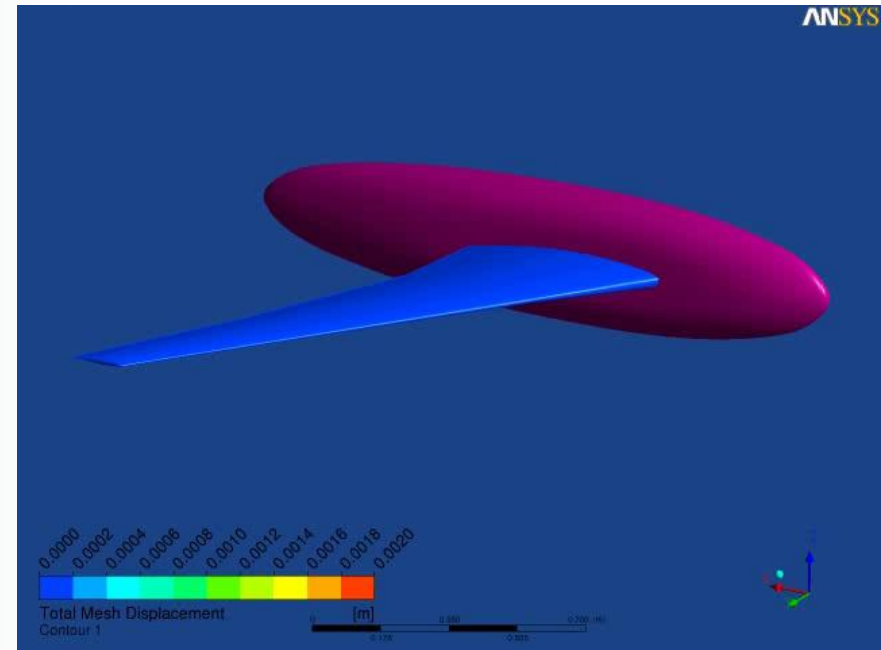

- Transient scheme
  - Second order backward Euler
- Convective discretization
  - High Resolution
- Initial condition
  - Steady-state solution
- Time steps per period
  - Run1: **32** > 3.125 ms
  - Run2: **64** > 1.562 ms
  - Run3: **128** > 0.781 ms
- Total time = 5 \* period
  - $32 * 5 = 160$  iterations
  - $64 * 5 = 320$  iterations
  - $128 * 5 = 640$  iterations

# CFX Solver, Grid 1, MAX Residuals

Timestep = Period/32

Timestep = Period/64

Timestep = Period/128

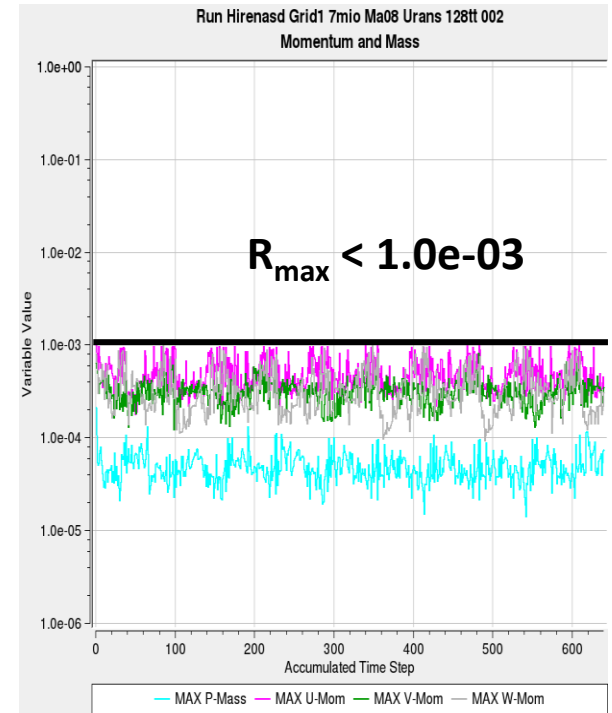
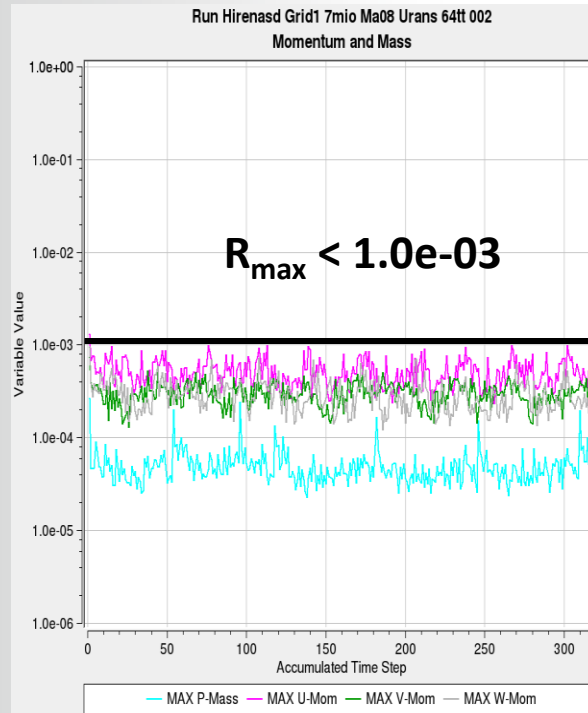
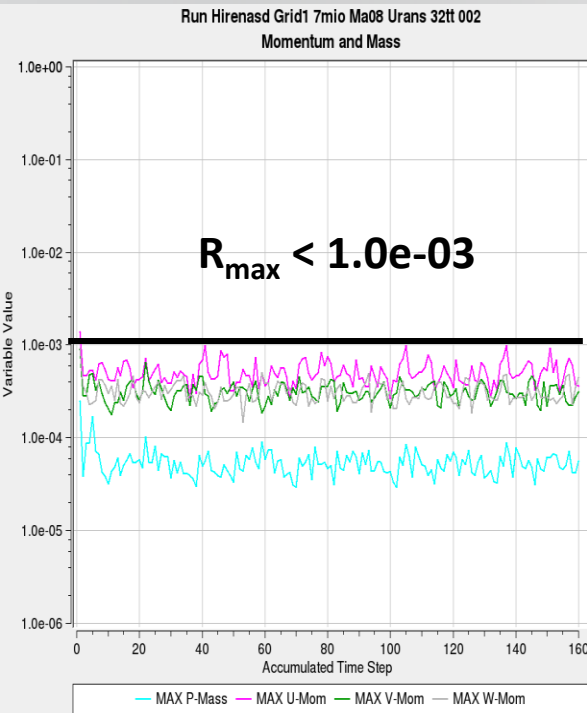

# RMS Residuals & CL

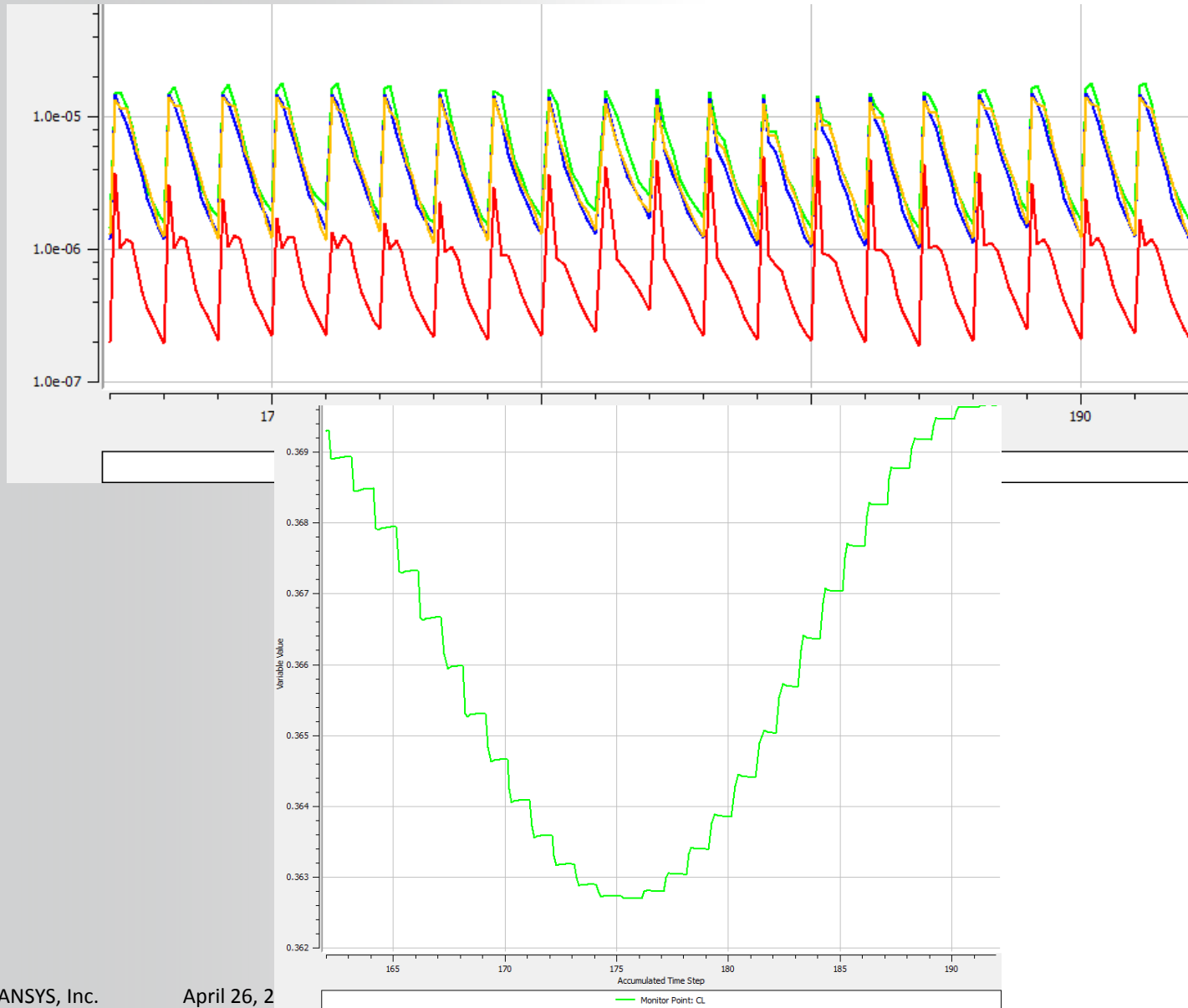



# Temporal Error

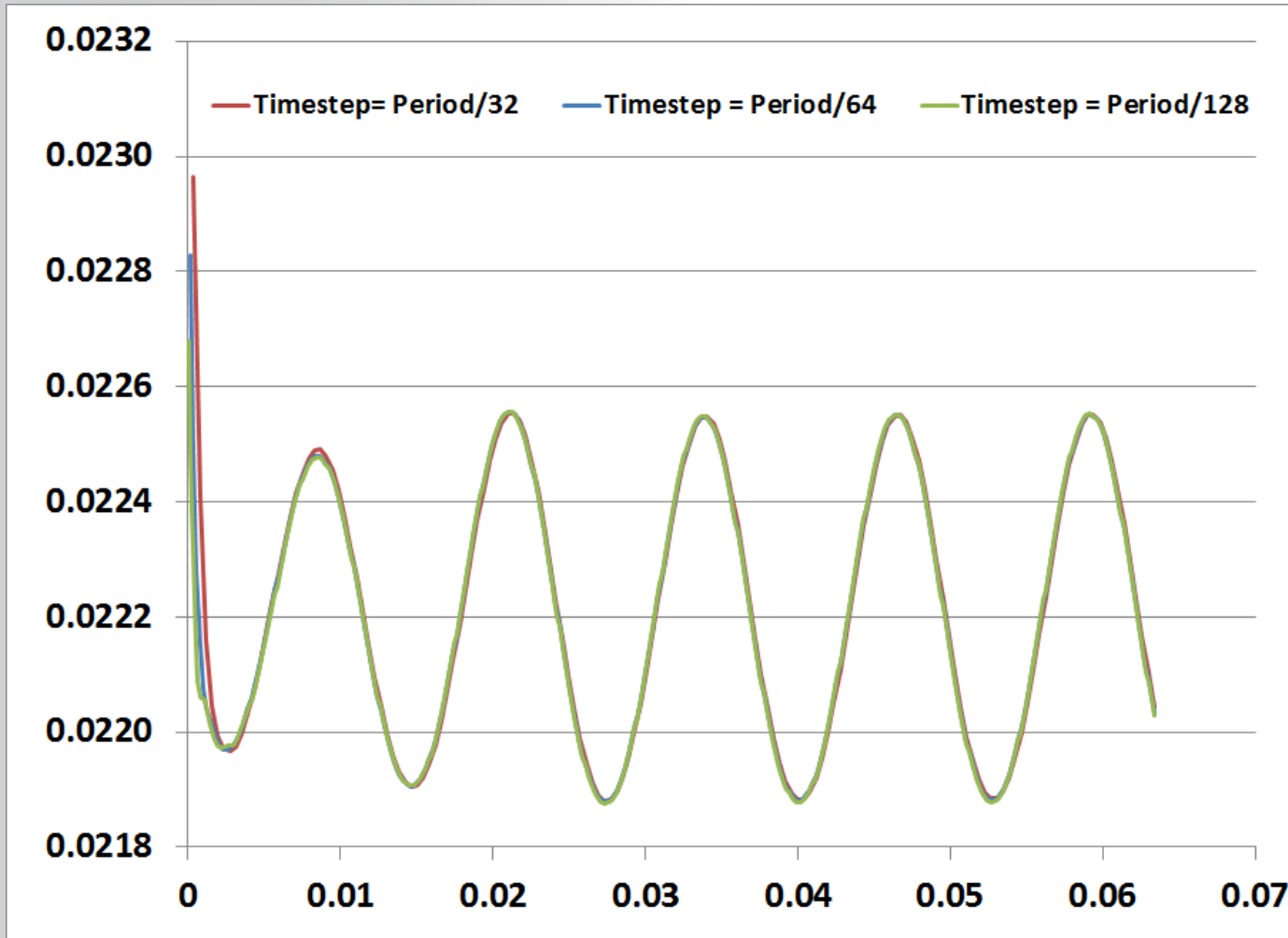

# Frequency Response Function

- **Fourier Series is written in form of sines and cosines**

$$x(t) = a_0 + \sum_{n=1}^{\infty} a_n \cos(n\omega_0 t) + b_n \sin(n\omega_0 t)$$

- **where for  $n > 0$ :**

$$a_n = \frac{2}{T} \int_{t_0}^{t_0+T} x(t) \cos(n\omega_0 t) dt, \quad b_n = \frac{2}{T} \int_{t_0}^{t_0+T} x(t) \sin(n\omega_0 t) dt$$

- **and where**

$$\omega_0 = \frac{2\pi}{T}, \quad a_0 = \frac{1}{T} \int_{t_0}^{t_0+T} x(t) dt$$

# Frequency Response Function

- Fourier coefficients calculated in CFD solver
- Additional Variable @ ANSYS CFX
  - CP Real, CP Imag
  - Magnitude =  $\sqrt{\text{CP Real}^2 + \text{CP Imag}^2}$
  - Phase =  $\text{atan2}(\text{CP Imag}/\text{CP Real})$

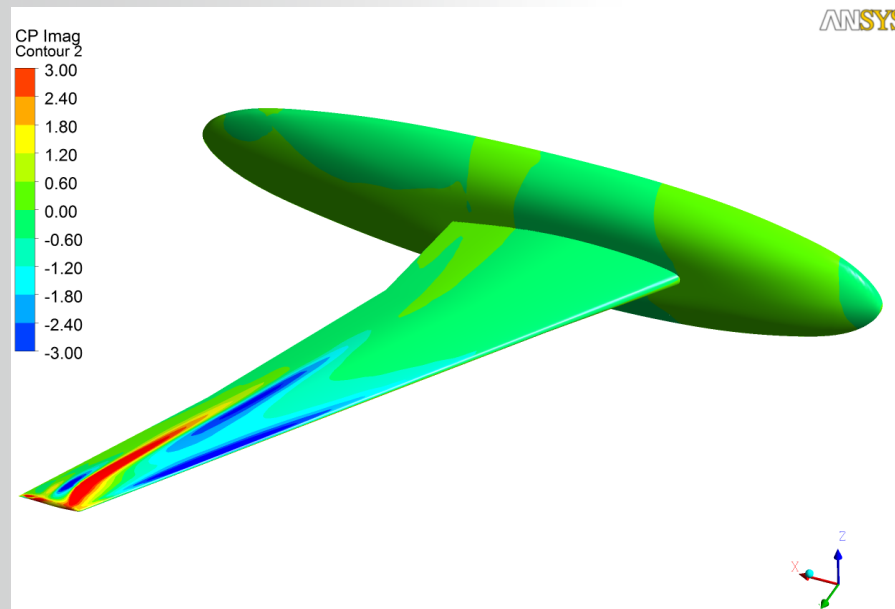

# Imag Cp: $Re = 7 \text{ mio}$ , $Ma = 0.8$ , $\alpha = 1.5^\circ$

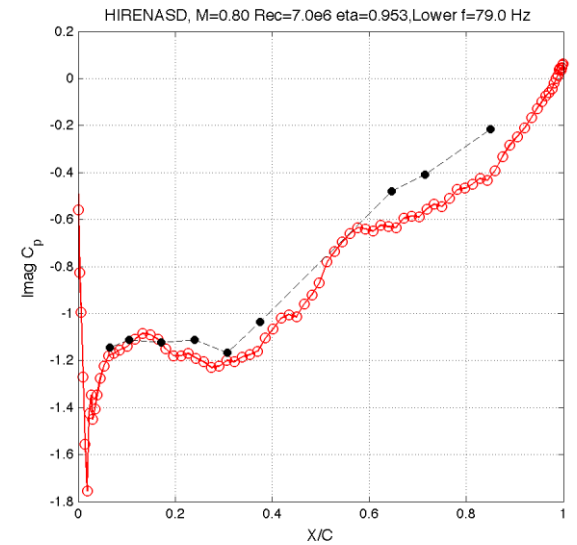
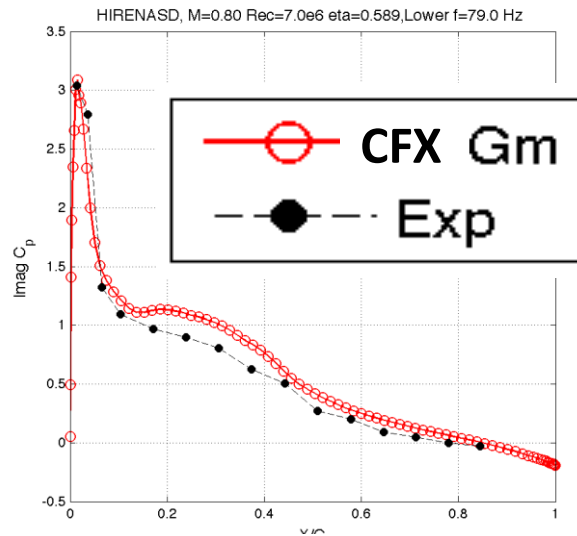
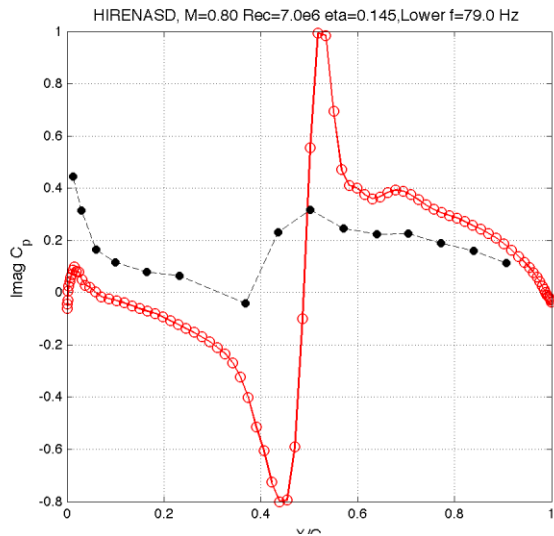

Plots created by Carol Wieseman, NASA

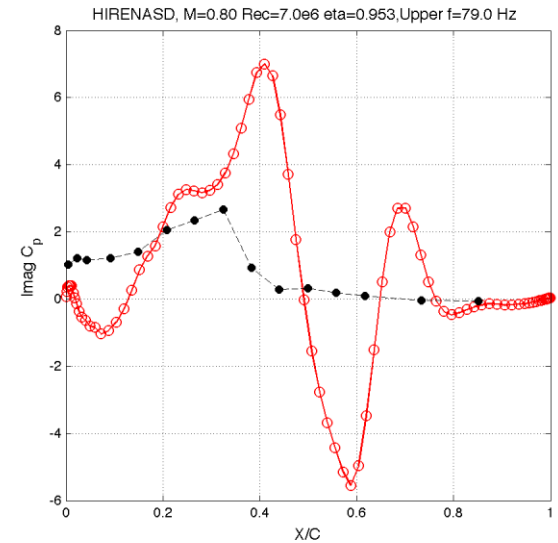
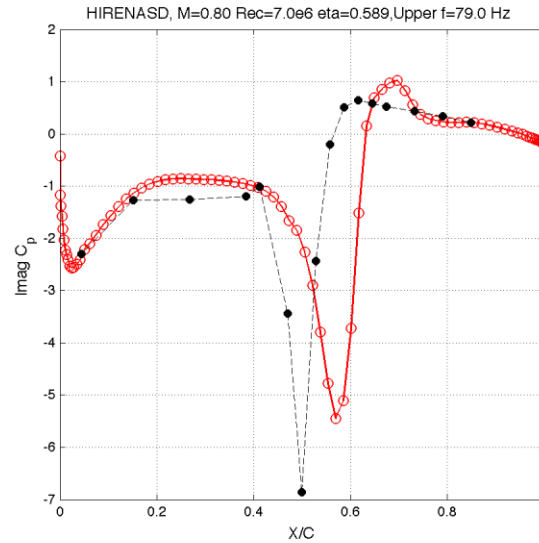
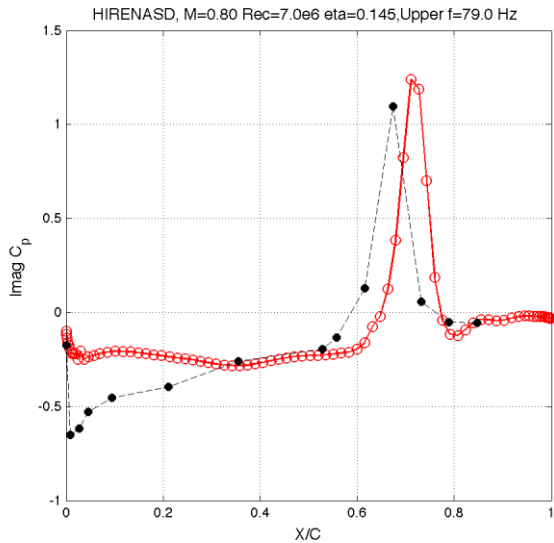

# Real Cp: Re = 7 mio, Ma = 0.8, $\alpha = 1.5^\circ$

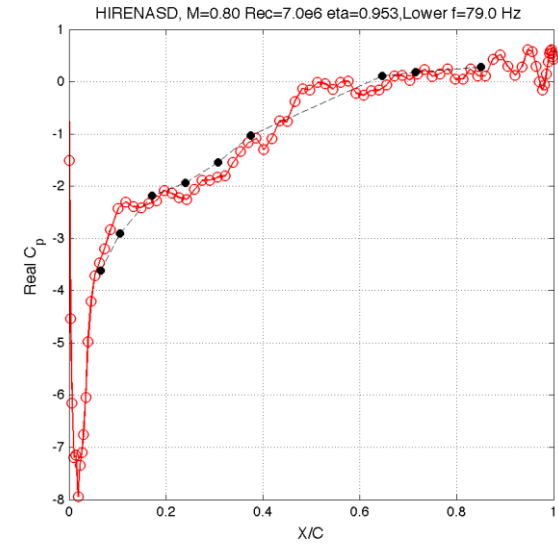
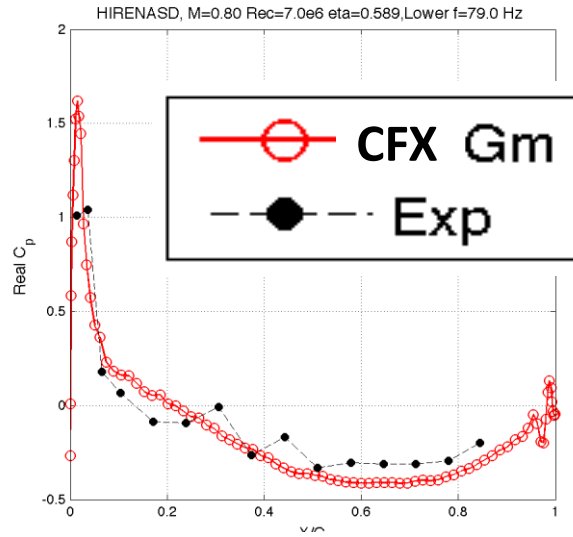
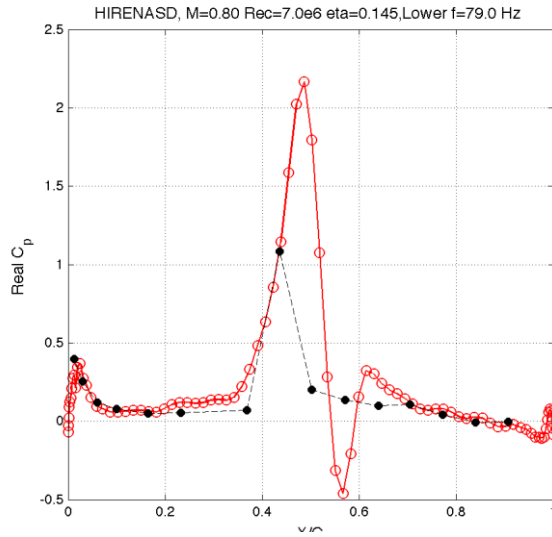

Plots created by Carol Wieseman, NASA

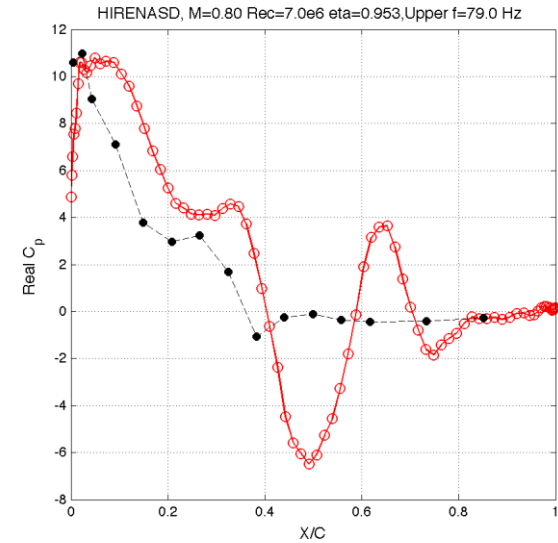
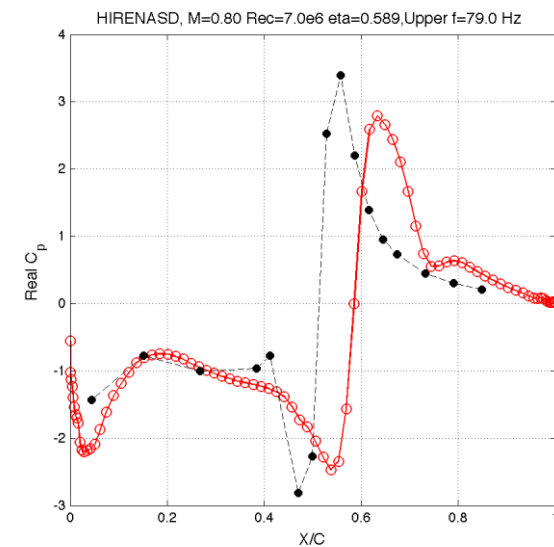
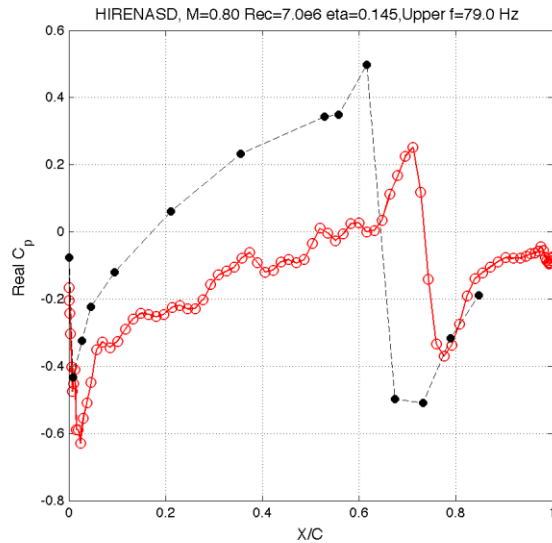

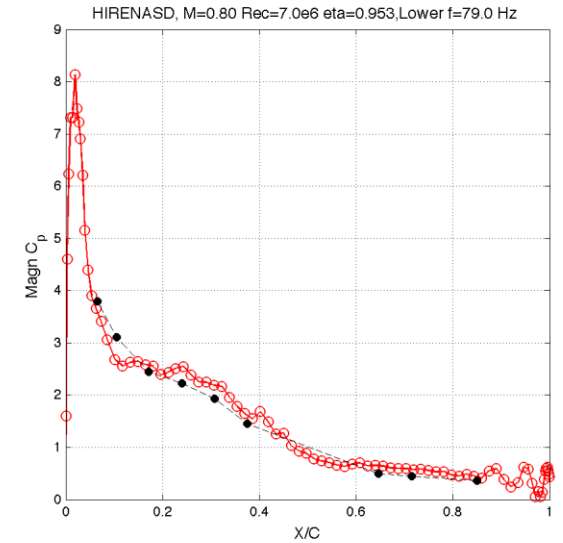
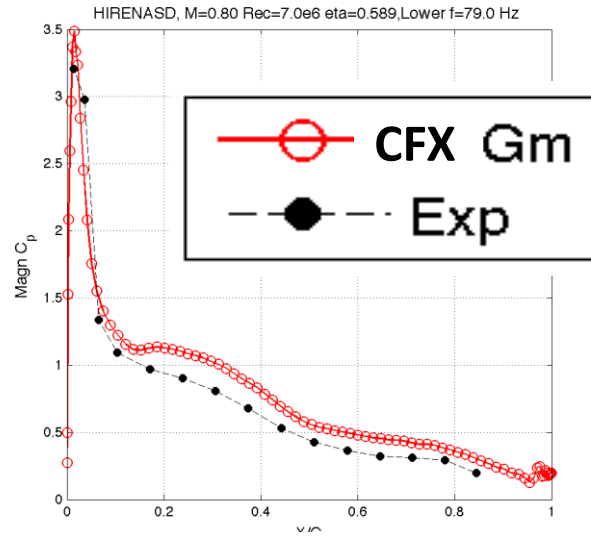
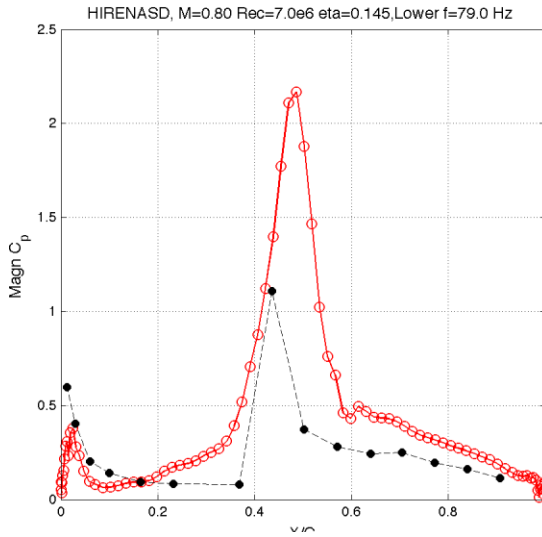

Plots created by Carol Wieseman, NASA

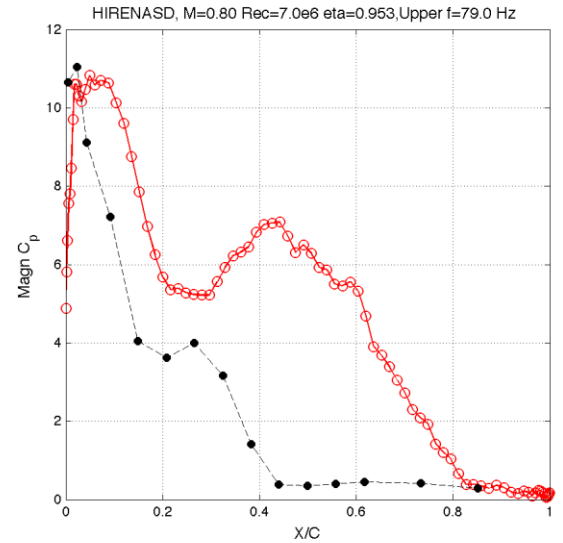
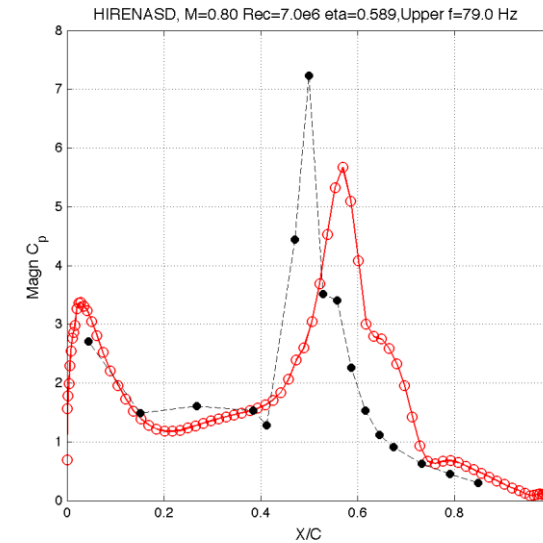
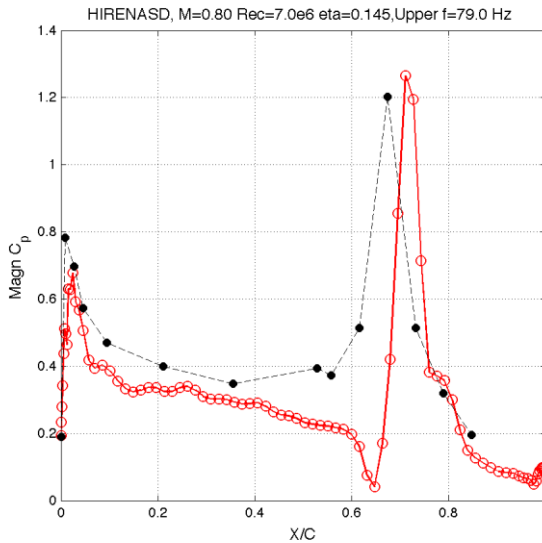



# Phase: $Re = 7 \text{ mio}$ , $Ma = 0.8$ , $\alpha = 1.5^\circ$

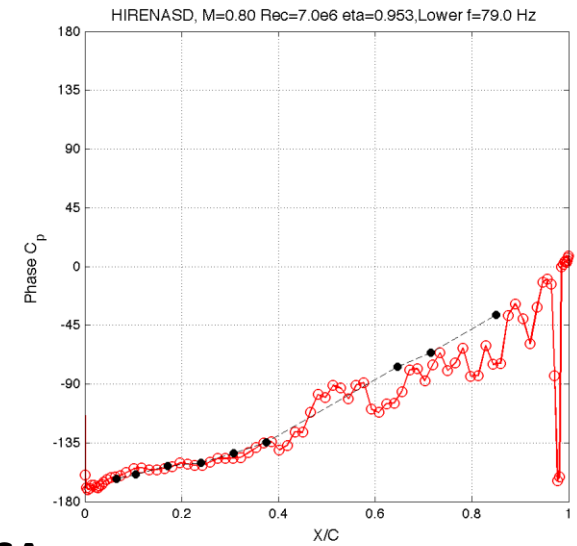
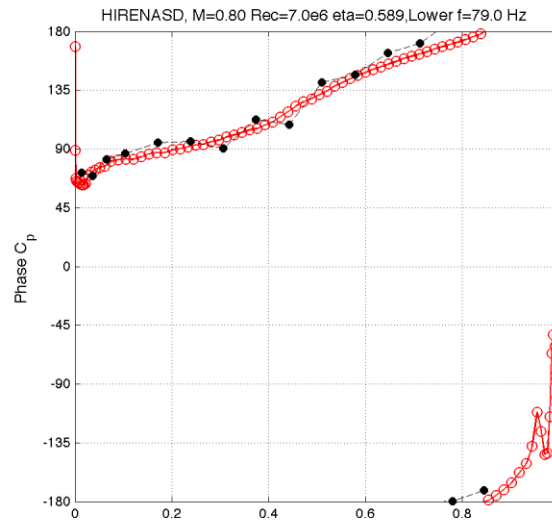
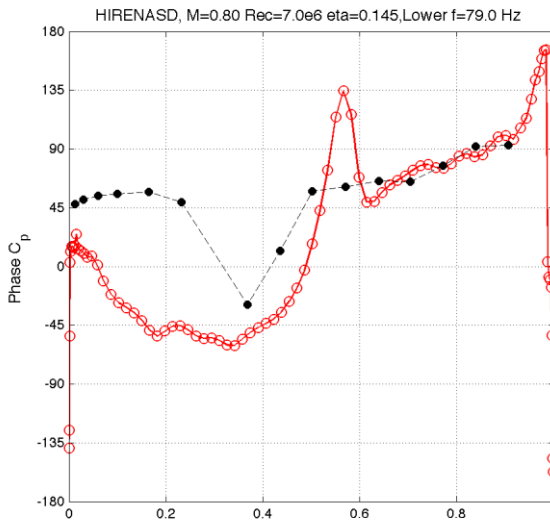

Plots created by Carol Wieseman, NASA

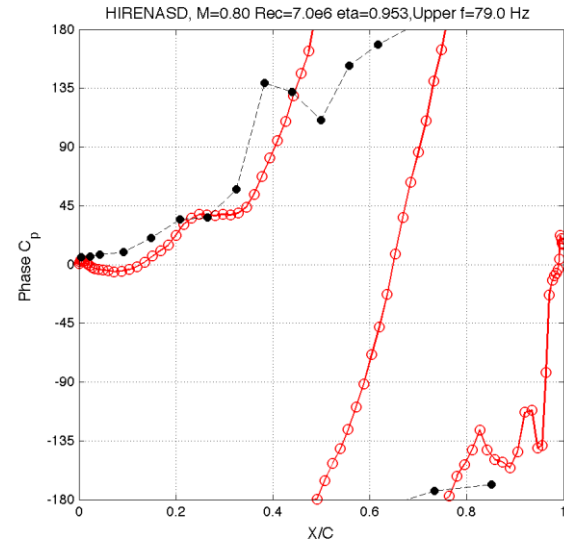
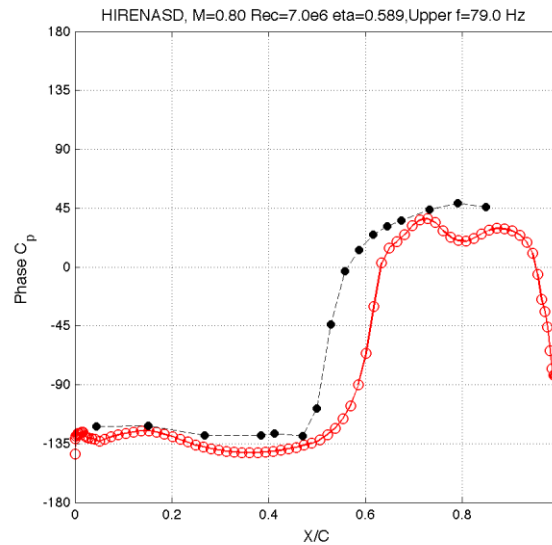
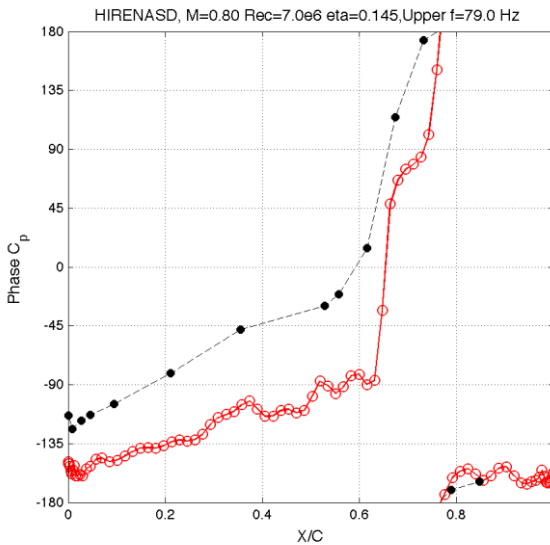

# Summary & Outlook

- ANSYS CFD calculation of a HIRENASD aeroelasticity case
- Detailed quality assurance of numerical errors
  - Iteration error
  - Discretization error (Spatial and temporal)
- Full Wind Tunnel model
- FEM Hex-mesh with real TE
- Dynamic coupling with ANSYS

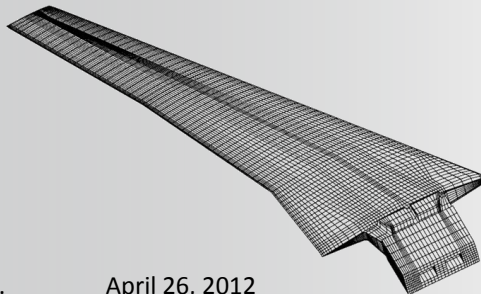

*Courtesy of RWTH Aachen*